

































mouluures • cornices • leisten • lijsten • CORNICI

articolo  
article  
style  
artikel  
artikel

lunghezza barre/length bars/morceau barres/Dauer pegelanzeige 150 cm \* 120 cm

cm

angoli • centine • mezzerie

3019			$\frac{0,7}{1,6}$			6017
41/B			$\frac{0,9}{1,9}$	85	96	
3077			$\frac{2,0}{2,0}$			
700			$\frac{1,1}{2,0}$	424	443	425
285			$\frac{0,8}{2,1}$	401	404	
62/B			$\frac{1,1}{2,2}$	118 403	93	
735			$\frac{1,2}{2,2}$			839
52/B			$\frac{1,5}{2,3}$	92	234	
791			$\frac{1,7}{2,3}$			
41/C			$\frac{1,1}{2,4}$	136 137	121	
* 616			$\frac{1,2}{2,6}$	850		
46/D			$\frac{1,2}{2,6}$	81	414	
720			$\frac{1,5}{2,6}$	828	819	
3029			$\frac{1,8}{2,6}$			
293			$\frac{1,9}{2,6}$			





























# CORNICI • moulures • cornices • leisten • lijsten

articolo  
article  
style  
artikel  
artikel

lunghezza barre/bar length/longueur barres/länge der Leisten 150 cm

cm

angoli • centine • mezzerie





























291			0,9 2,8	409 421	408
306/D			1,0 2,8	61A	804
299			1,7 2,8	827	417
20/D			1,1 2,9	822	269
753			1,2 3,0		6012
288			1,3 3,0		406
61/B			1,4 3,0	260 91	233
789			1,4 3,0		
3018			1,8 3,0		
36/B			1,1 3,1	872 261	871 97
721			1,9 3,1	851	820
49/B			1,7 3,2	74 214	849 215
60/B			1,9 3,2		
23/C			1,3 3,3	134	94 430



articolo  
article  
style  
artikel  
artikel

lunghezza barre/bar length/longueur barres/länge der Leisten 150 cm

angoli • centine • mezzerie

			cm				
702			1,4	3,3	432	846	
28/C			1,7	3,3	883		6008
46/B			1,7	3,3		6015	
289			3,3	3,3			
3013			3,3	3,3			
277			1,3	3,4	6009	407	
255			0,8	3,5	135	257	
779			1,5	3,5		6018	
790			1,5	3,5			
740			1,8	3,6	6026	840	6027
24/B			1,5	3,7	88	230	
68/B			1,6	3,7	259	267	802 226
38/B			1,7	3,7	70	413	
284			1,7	3,7	826	405	





























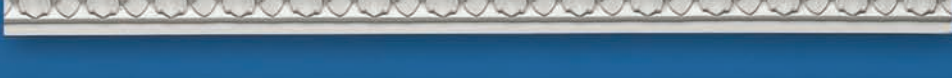

# CORNICI • moulures • cornices • leisten • lijsten

articolo  
article  
style  
artikel  
artikel

lunghezza barre/bar length/longueur barres/länge der Leisten 150 cm

cm

angoli • centine • mezzerie

292			3/A 411	410
35/B			824	95 825
27/B			98 99	232
65/B			220 225	222
704			13/A 823	813
737				
24/C				
23/B			89 90	876
754				6013
66/B			427 147	268
57/B				271
788				
48/A			84	231
707			442	845

articolo article style artikel artikel	lunghezza barre/bar length/longueur barres/länge der Leisten 150 cm	cm	angoli • centine • mezzerie
758		2,1 4,3	
50/B		1,7 4,4	77 223 816
55/B		1,8 4,4	270
283		4,1 4,4	
780		2,6 4,5	
3038		2,8 4,5	
210		1,5 4,8	216 229 217
254		1,8 4,8	
63/B		2 4,8	869 235
56/B		2,4 4,8	
706		2,2 4,9	441 844
701		0,9 5	431
3020		1 5	
276		2 5	868 866 867 865

























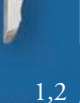

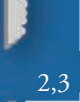

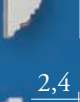
CORNICI • moulures • cornices • leisten • lijsten

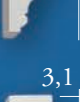
articolo  
article  
style  
artikel  
artikel

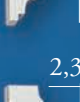













lunghezza barre/bar length/longueur barres/länge der Leisten 150 cm \* 200 cm

cm

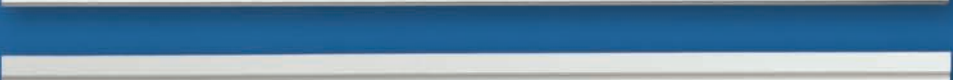
angoli • centine • mezzerie

715			2 5	102L 6019	
3022			2 5	877	879 878 880
793			2,2 5		
211			2,3 5	6028	6023
3030			2,5 5		
* 2017			5 5		
208			1,8 5,1	206	205
777			1,2 5,2		
771			2,3 5,2		
3003			2,4 5,2	6011	861
776			3,1 5,2		
49/C			2,3 5,4		
278			2,5 5,5	6021	
772			1,8 5,5		



articolo article style artikel artikel	lunghezza barre/bar length/longueur barres/länge der Leisten 150 cm	cm	angoli • centine • mezzerie
209		2 5,5	212 213
49/A		3 5,5	
732		2 5,6	834 875 835 855 856
265		1,9 5,7	434 870
3002		2 5,8	862 6010 860 863
21/C		2,5 5,8	852 853 854
3001		2,2 5,9	857 858 859
787		2 6	6014
3024		2,1 6	
794		3,2 6	
3037		3,2 6	
3040		3,6 6	
240		1,4 6,2	251 246 252
792		3 6,2	





























CORNICI • moulures • cornices • leisten • lijsten

articolo  
article  
style  
artikel  
artikel

lunghezza barre/bar length/longueur barres/länge der Leisten 150 cm

cm

angoli • centine • mezzerie

290			1,5 6,3
37/B			2,8 6,3
722			6,7 6,3
300			3,2 6,4
253			1,3 6,7
786			2,2 6,7
3017			1,7 6,9
1/B			2,3 7
310/D			2,3 7
2/B			3,5 7
53/B			3,3 7
296			3 7
3016			2,1 7,2
752			2,9 7,2

418

841

6016

















articolo  
article  
style  
artikel  
artikel

lunghezza barre/bar length/longueur barres/länge der Leisten 150 cm

cm

angoli • centine • mezzerie

3007		4 7,2		
3041		4,3 7,2		
54/B		3,2 7,4		
64/B		3 7,4		
759		3,9 7,4		
727		1,5 7,5	833	6020
798		2,3 7,5		
705		3,4 7,5	847	
3021		1 7,6		
279		3 7,6		
282		3,8 7,7		
796		6 7,8		
784		2,3 7,8		
726		4 7,8		

















CORNICI • moulures • cornices • leisten • lijsten













articolo  
article  
style  
artikel  
artikel

lunghezza barre/bar length/longueur barres/länge der Leisten 150 cm \* 200 cm

cm

angoli • centine • mezzerie

262		1,5 8	
778		5,5 8	
708		3,6 8,5	
280		1,5 8,7	836
738		3,5 8,8	
768		3,5 9	
* 3009		3 9,2	882/S 882/D
* 3008		2 9,5	
709		3,7 9,5	
797		7,2 9,6	
3043		1,2 9,9	
724		4,3 9,9	
* 3025		2,1 10	
795		3,7 10	

articolo article style artikel artikel	lunghezza barre/length bars/morceau barres/Dauer pegelanzeige 150 cm	cm	angoli • centine • mezzerie
3078		6,1	10,1
3079		5,5	10
766		6	10
3069		2,5	10
275		2,5	10,1
3012		4,3	10,1
3035		4,3	10,1
3036		4,3	10,1
3042		4	10,2
3053		1,5	12,1
723		4	11,2
3004		3,9	11,7



lunghezza barre/length bars/morceau barres/Dauer pegelanzeige 150 cm











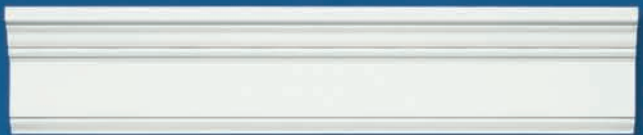









cm angoli • centine • mezzerie

747			6 12
767			7,7 12,3
3010			1,7 12,6
3005			7 13,1
703			3,7 13,5
3006			7,5 13,5
748			4,5 13,6
281			4,5 13,8
3032			5 14
3060			4 15,6
3051			8,4 18



lunghezza barre/length bars/morceau barres/Dauer pegelanzeige 150 cm \* 140 cm

cm angoli • centine • mezzerie

782			6,5	19,3
3011			2,3	19,6
749			8,3	19,7
775			3,3	20,2
3058			2,1	19,3
3061			4,3	16
750			6,1	20,2
763			1,8	20,4
* 774			2	24,3
3068			9,8	28,1

# CORNICI • moulures • cornices • leisten • lijsten

articolo  
article  
style  
artikel  
artikel

lunghezza barre/length bars/morceau barres/Dauer pegelanzeige 150 cm

cm angoli • centine • mezzerie

Pens 5



2  
|  
5

Pens 10



2  
|  
10

Pens 14



2  
|  
14,5



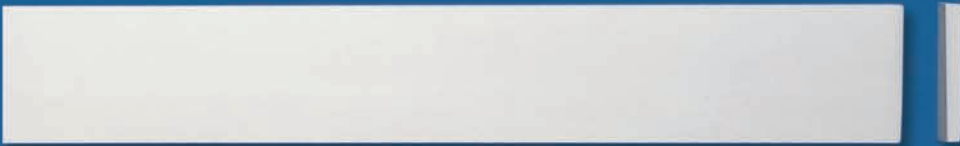



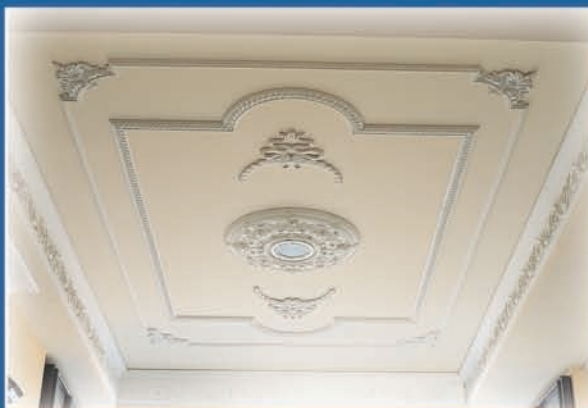























Pens 18





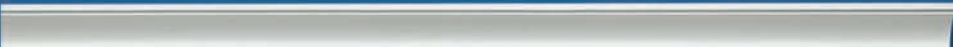

























2  
|  
18































203			$\begin{array}{l} \text{cm } 3 \\ 3 \diagup 4 \end{array}$
741			$\begin{array}{l} \text{cm } 7,6 \\ 3,8 \diagup 8,4 \end{array}$
3027			$\begin{array}{l} \text{cm } 6 \\ 4,8 \diagup 7,5 \end{array}$
746			$\begin{array}{l} \text{cm } 5,2 \\ 4,9 \diagup 7 \end{array}$
725			$\begin{array}{l} \text{cm } 5,2 \\ 5,5 \diagup 7,2 \end{array}$
734			$\begin{array}{l} \text{cm } 3 \\ 5,4 \diagup 6 \end{array}$
201			$\begin{array}{l} \text{cm } 6,3 \\ 6 \diagup 9 \end{array}$
202			$\begin{array}{l} \text{cm } 6,3 \\ 6 \diagup 9 \end{array}$
204			$\begin{array}{l} \text{cm } 6,3 \\ 6 \diagup 9 \end{array}$
3023			$\begin{array}{l} \text{cm } 6,7 \\ 6,5 \diagup 9 \end{array}$
298			$\begin{array}{l} \text{cm } 7,8 \\ 6,5 \diagup 10 \end{array}$
761			$\begin{array}{l} \text{cm } 6,5 \\ 6,7 \diagup 9,3 \end{array}$
3049			$\begin{array}{l} \text{cm } 4,8 \\ 5,1 \diagup 6,7 \end{array}$
3050			$\begin{array}{l} \text{cm } 6 \\ 6 \diagup 8,1 \end{array}$
717			$\begin{array}{l} \text{cm } 6,5 \\ 7,2 \diagup 9,5 \end{array}$

lunghezza barre/length bars/morceau barres/Dauer pegelanzeige 150 cm





















298/B			$\begin{array}{l} \text{cm 7} \\ 7 \diagup 9,7 \end{array}$
742			$\begin{array}{l} \text{cm 5,6} \\ 7,1 \diagup 8,8 \end{array}$
770			$\begin{array}{l} \text{cm 6} \\ 7,5 \diagup 9,5 \end{array}$
3028			$\begin{array}{l} \text{cm 6,5} \\ 7,6 \diagup 10 \end{array}$
3000			$\begin{array}{l} \text{cm 14} \\ 7,6 \diagup 16 \end{array}$
756			$\begin{array}{l} \text{cm 7,2} \\ 8 \diagup 10,6 \end{array}$
769			$\begin{array}{l} \text{cm 7} \\ 8 \diagup 10,3 \end{array}$
762			$\begin{array}{l} \text{cm 9,7} \\ 8,2 \diagup 12,4 \end{array}$
718			$\begin{array}{l} \text{cm 10,1} \\ 8,4 \diagup 12,8 \end{array}$
3015			$\begin{array}{l} \text{cm 8} \\ 8,5 \diagup 11,5 \end{array}$
3057			$\begin{array}{l} \text{cm 8,5} \\ 8,5 \diagup 12,1 \end{array}$
745			$\begin{array}{l} \text{cm 9,5} \\ 8,5 \diagup 12,7 \end{array}$
757			$\begin{array}{l} \text{cm 8} \\ 8,6 \diagup 11,5 \end{array}$
3014			$\begin{array}{l} \text{cm 10,2} \\ 8,8 \diagup 13,5 \end{array}$



lunghezza barre/length bars/morceau barres/Dauer pegelanzeige 150 cm

715/S			$\begin{array}{l} \text{cm } 8,7 \\ 8,8 \text{ --- } 12,2 \\ \text{---} \end{array}$
711			$\begin{array}{l} \text{cm } 8 \\ 9 \text{ --- } 12,2 \\ \text{---} \end{array}$
295			$\begin{array}{l} \text{cm } 10,3 \\ 9 \text{ --- } 13,3 \\ \text{---} \end{array}$
3031			$\begin{array}{l} \text{cm } 11,2 \\ 9,2 \text{ --- } 14,2 \\ \text{---} \end{array}$
295/B			$\begin{array}{l} \text{cm } 10 \\ 9,4 \text{ --- } 13,5 \\ \text{---} \end{array}$
294			$\begin{array}{l} \text{cm } 9,2 \\ 10,2 \text{ --- } 13,5 \\ \text{---} \end{array}$
773			$\begin{array}{l} \text{cm } 9 \\ 10 \text{ --- } 13,4 \\ \text{---} \end{array}$
3039			$\begin{array}{l} \text{cm } 10,3 \\ 10,1 \text{ --- } 14 \\ \text{---} \end{array}$
3055			$\begin{array}{l} \text{cm } 10,1 \\ 10,1 \text{ --- } 14,2 \\ \text{---} \end{array}$
744			$\begin{array}{l} \text{cm } 10,8 \\ 10,2 \text{ --- } 15 \\ \text{---} \end{array}$
719			$\begin{array}{l} \text{cm } 8,9 \\ 10,5 \text{ --- } 13,6 \\ \text{---} \end{array}$
755			$\begin{array}{l} \text{cm } 8,5 \\ 10,5 \text{ --- } 13,5 \\ \text{---} \end{array}$
3056			$\begin{array}{l} \text{cm } 11,2 \\ 11,2 \text{ --- } 16 \\ \text{---} \end{array}$

lunghezza barre/length bars/morceau barres/Dauer pegelanzeige 150 cm

3052			$\begin{array}{r} \text{cm } 11,6 \\ 11,6 \quad \diagup \\ \quad \quad 16,2 \end{array}$
733			$\begin{array}{r} \text{cm } 16,5 \\ 11,8 \quad \diagup \\ \quad \quad 20,5 \end{array}$
760			$\begin{array}{r} \text{cm } 13 \\ 12,5 \quad \diagup \\ \quad \quad 18 \end{array}$
743			$\begin{array}{r} \text{cm } 13,5 \\ 12 \quad \diagup \\ \quad \quad 18 \end{array}$
785			$\begin{array}{r} \text{cm } 11,5 \\ 12 \quad \diagup \\ \quad \quad 16,8 \end{array}$
783			$\begin{array}{r} \text{cm } 11,5 \\ 17 \quad \diagup \\ \quad \quad 20,3 \end{array}$
716			$\begin{array}{r} \text{cm } 14,1 \\ 13,3 \quad \diagup \\ \quad \quad 19 \end{array}$
3054			$\begin{array}{r} \text{cm } 10 \\ 9,2 \quad \diagup \\ \quad \quad 13,5 \end{array}$
712			$\begin{array}{r} \text{cm } 13 \\ 12,5 \quad \diagup \\ \quad \quad 17,6 \end{array}$
713			$\begin{array}{r} \text{cm } 19,6 \\ 12,7 \quad \diagup \\ \quad \quad 22 \end{array}$



lunghezza barre/length bars/morceau barres/Dauer pegelanzeige 150 cm

3046

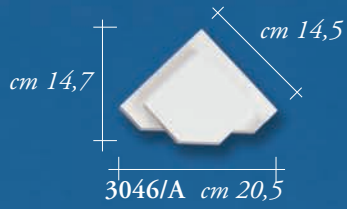
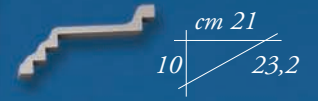

3046 + 3046/A

3046 + 3046/B

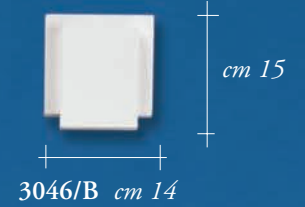

3046/B cm 14

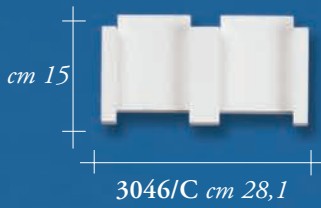

3046/C cm 28,1



3046 + 3046/C

3046 + 3046/D



3046/D cm 30



3046 + 3046/A

3046 + 3046/C

3046 + 3046/D

3046 + 3046/B

3044

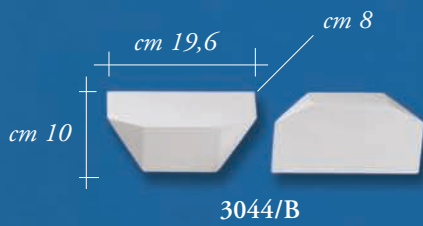
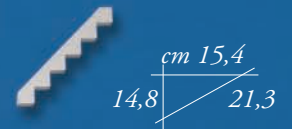

3044/B

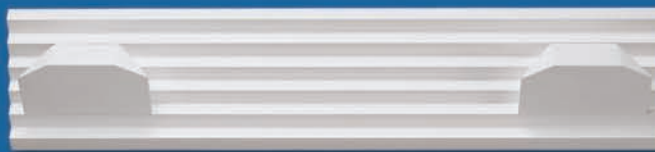

3044 + 3044/B

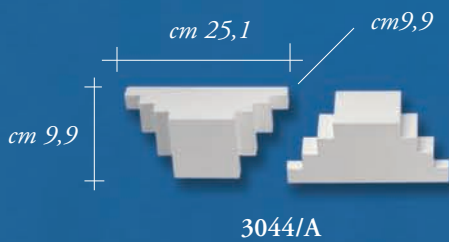

3044/A



3044 + 3044/A



3044 + 3044/A + 3044/B

lunghezza barre/length bars/morceau barres/Dauer pegelanzeige 150 cm

799

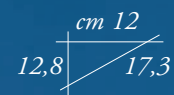

297

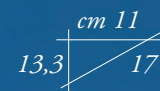

3033

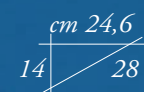
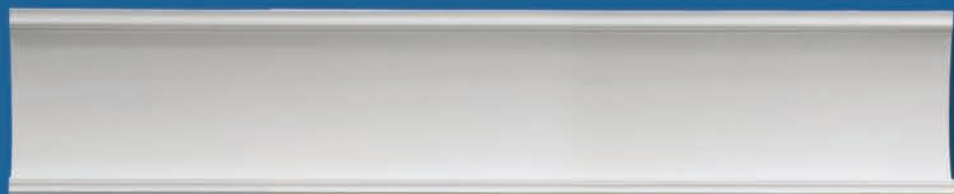

3034

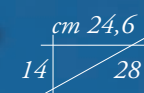

731

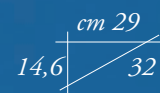

730

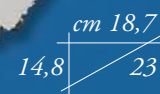

764

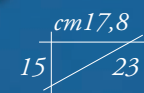

765

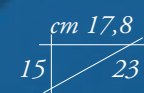



lunghezza barre/length bars/morceau barres/Dauer pegelanzeige 150 cm

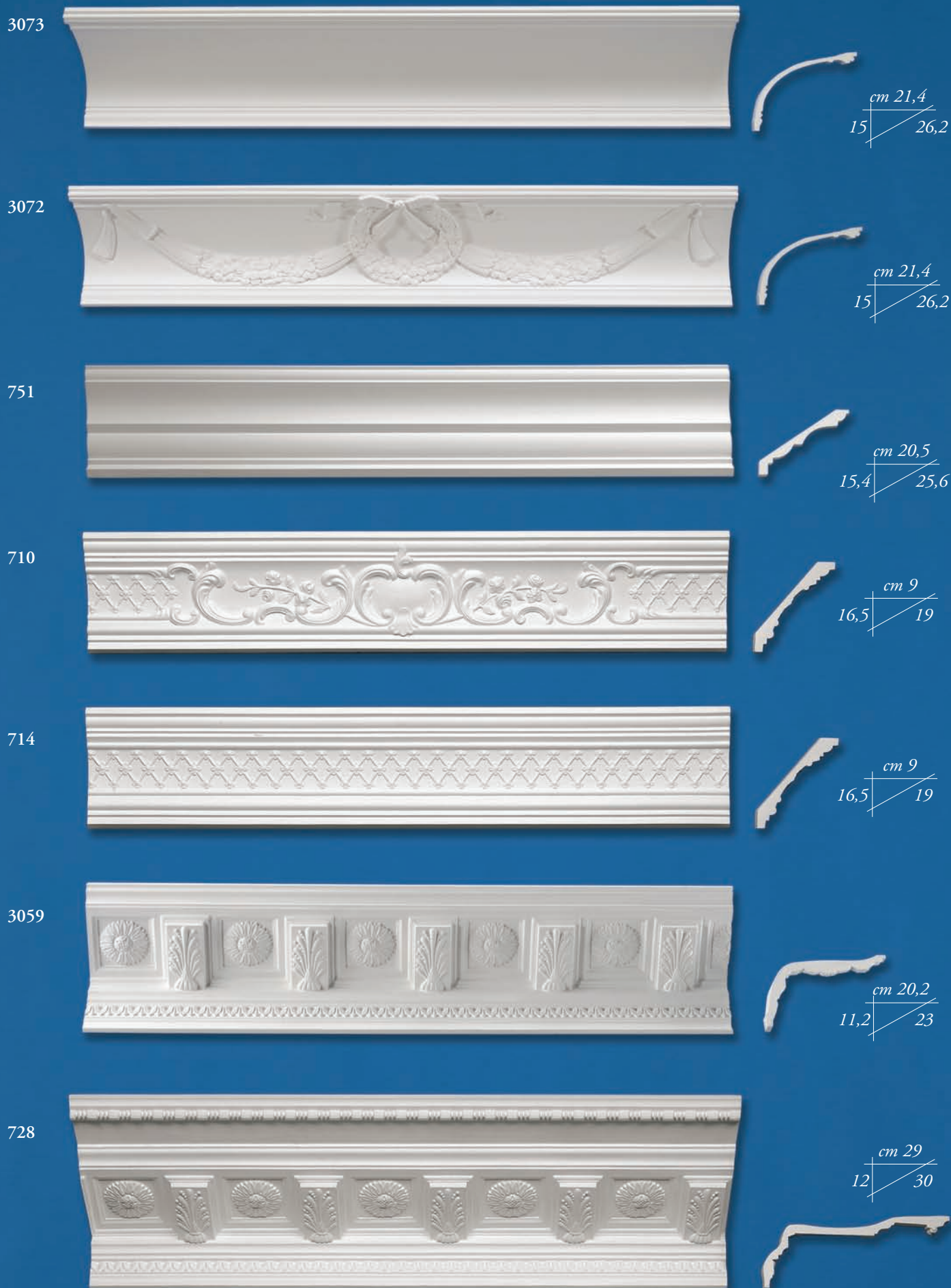

lunghezza barre/length bars/morceau barres/Dauer pegelanzeige 150 cm

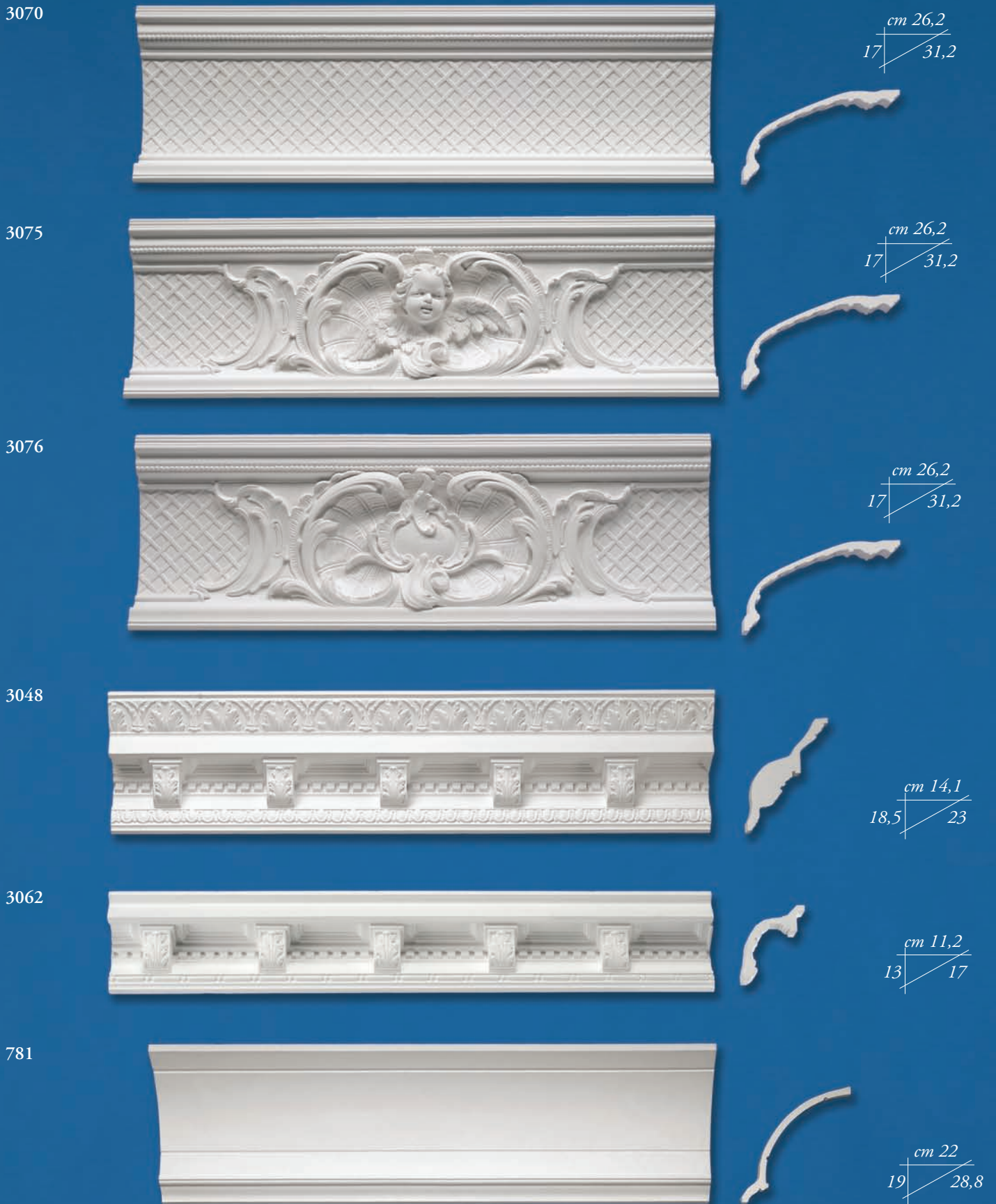



lunghezza barre/length bars/morceau barres/Dauer pegelanzeige 150 cm

3074



cm 31,4  
19,1 / 36,8



3074  
+ 3074/C



3074/C



cm 31,4  
19,1 / 36,8



3026



cm 21  
20,5 / 29,4



729



cm 31,5  
20,5 / 37



739



cm 22  
20,7 / 30



8/S



cm 15,2  
21 / 25,8



9/S



cm 15,2  
21 / 25,8



SGUSCIONI • corniches • cover-angles • schalen • kooflijsten

lunghezza barre/length bars/morceau barres/Dauer pegelanzeige 150 cm

736



$\frac{cm\ 30,4}{21,9 \quad 37}$

3047



$\frac{cm\ 19,6}{22,4 \quad 29,5}$

3071



$\frac{cm\ 21,4}{21,8 \quad 29,6}$

lunghezza barre 146 cm

3065



$\frac{cm\ 25,5}{38,8 \quad 46,4}$

lunghezza barre 145 cm

3064



$\frac{cm\ 28,1}{39,2 \quad 48,1}$

lunghezza barre 140 cm

3063



$\frac{cm\ 34,8}{38,7 \quad 51,4}$

lunghezza barre 146 cm

3066



3066/A

$\frac{cm\ 25,7}{\quad \quad cm\ 25,7}$

lunghezza barre 146 cm

3067

$\frac{cm\ 20}{49 \quad 52,9}$

3066/C



$\frac{cm\ 20}{49 \quad 52,9}$

lunghezza barre/length bars/morceau barres/Dauer pegelanzeige 150 cm - \* 200cm

PCA-200  
\*

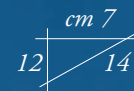

PCE-200  
\*

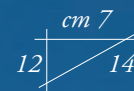

PCD-200  
\*

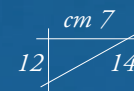

PCG-200  
\*

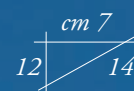

PCS-200  
\*

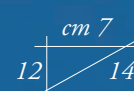

G 3

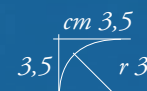

G 5

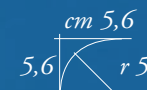

G 7

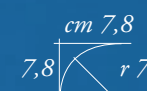

G 10

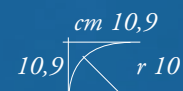

G 15

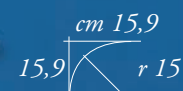
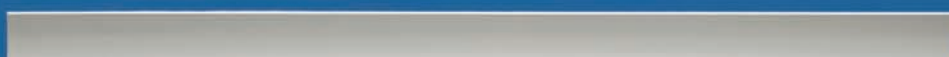

G 20

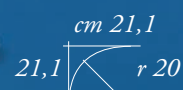



lunghezza barre/length bars/morceau barres/Dauer pegelanzeige 150 cm





altezza  
8 cm  
10 cm  
12 cm  
14 cm  
16 cm  
18 cm  
20 cm  
22 cm

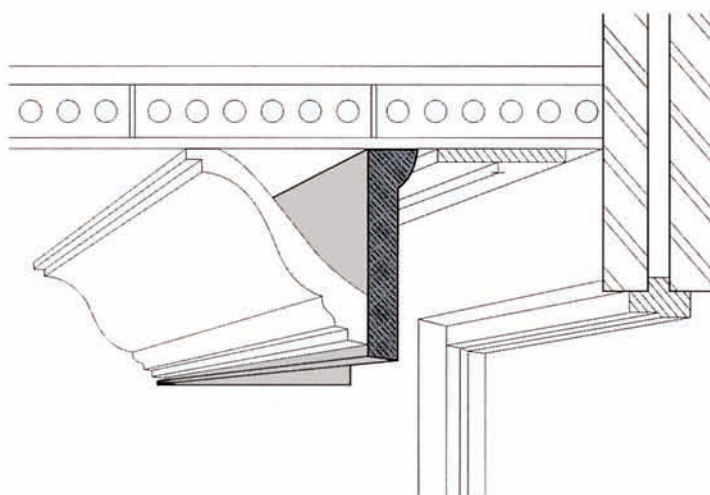





moulures décorative • angles • ecken • hoeken • ANGOLI

lunghezza barre/lunghezza barre/lunghezza barrelunghezza barre 1000 mm

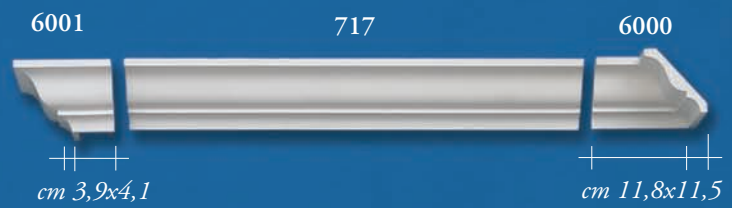
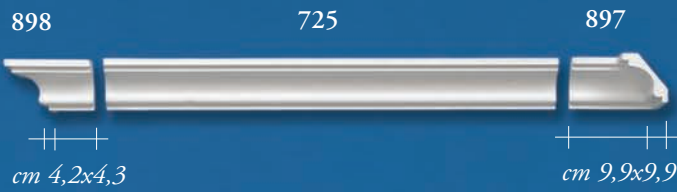

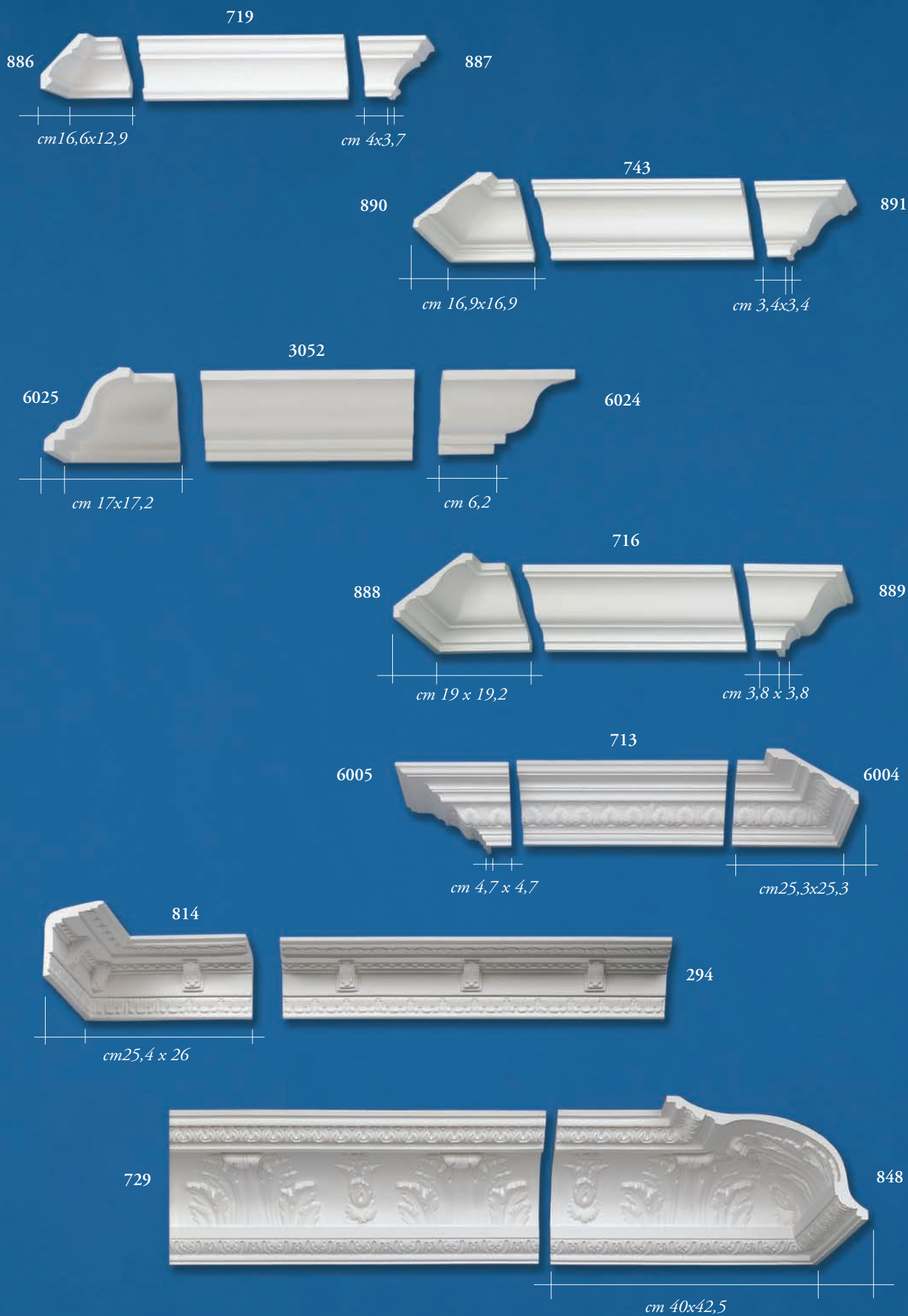

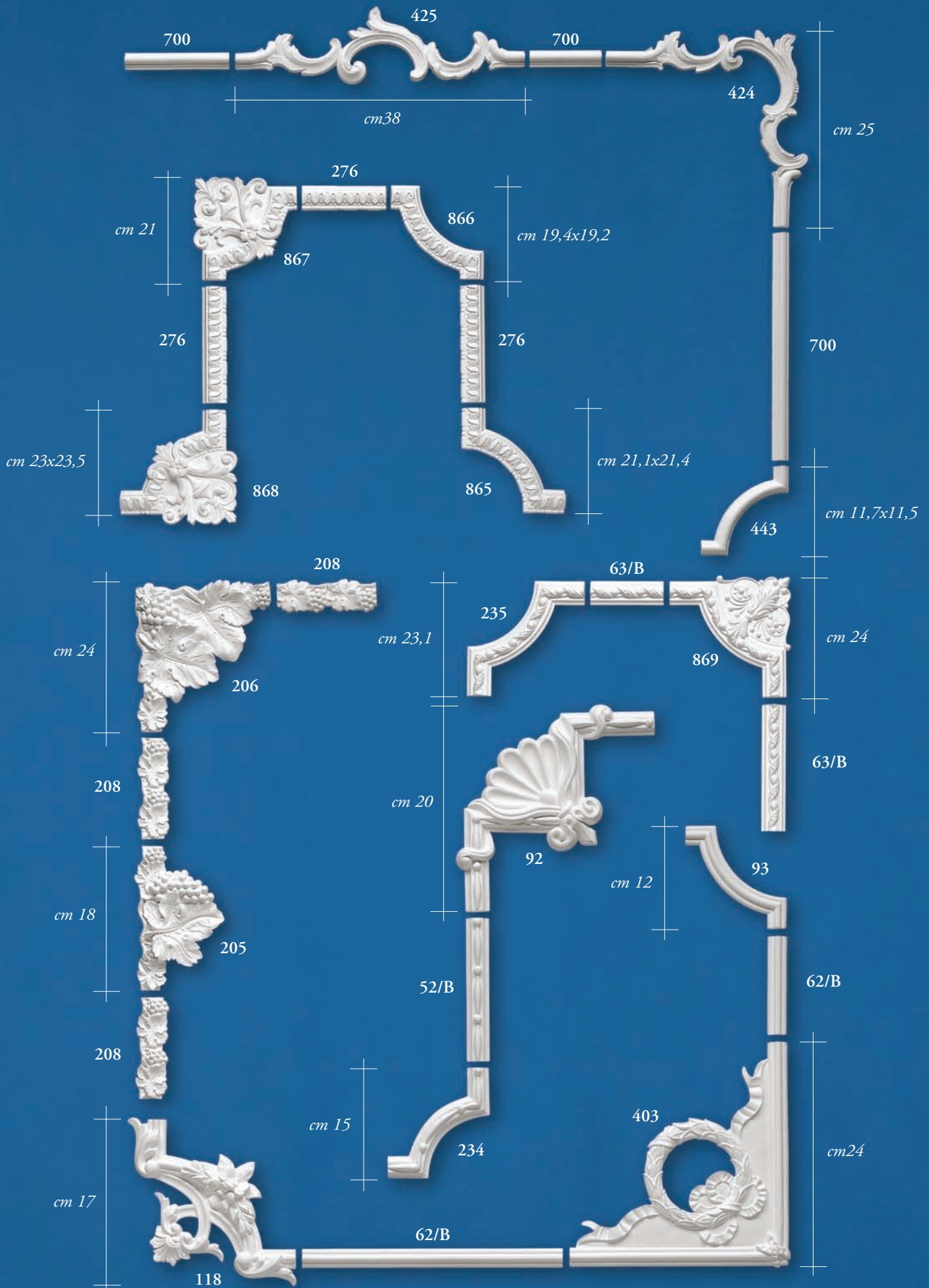



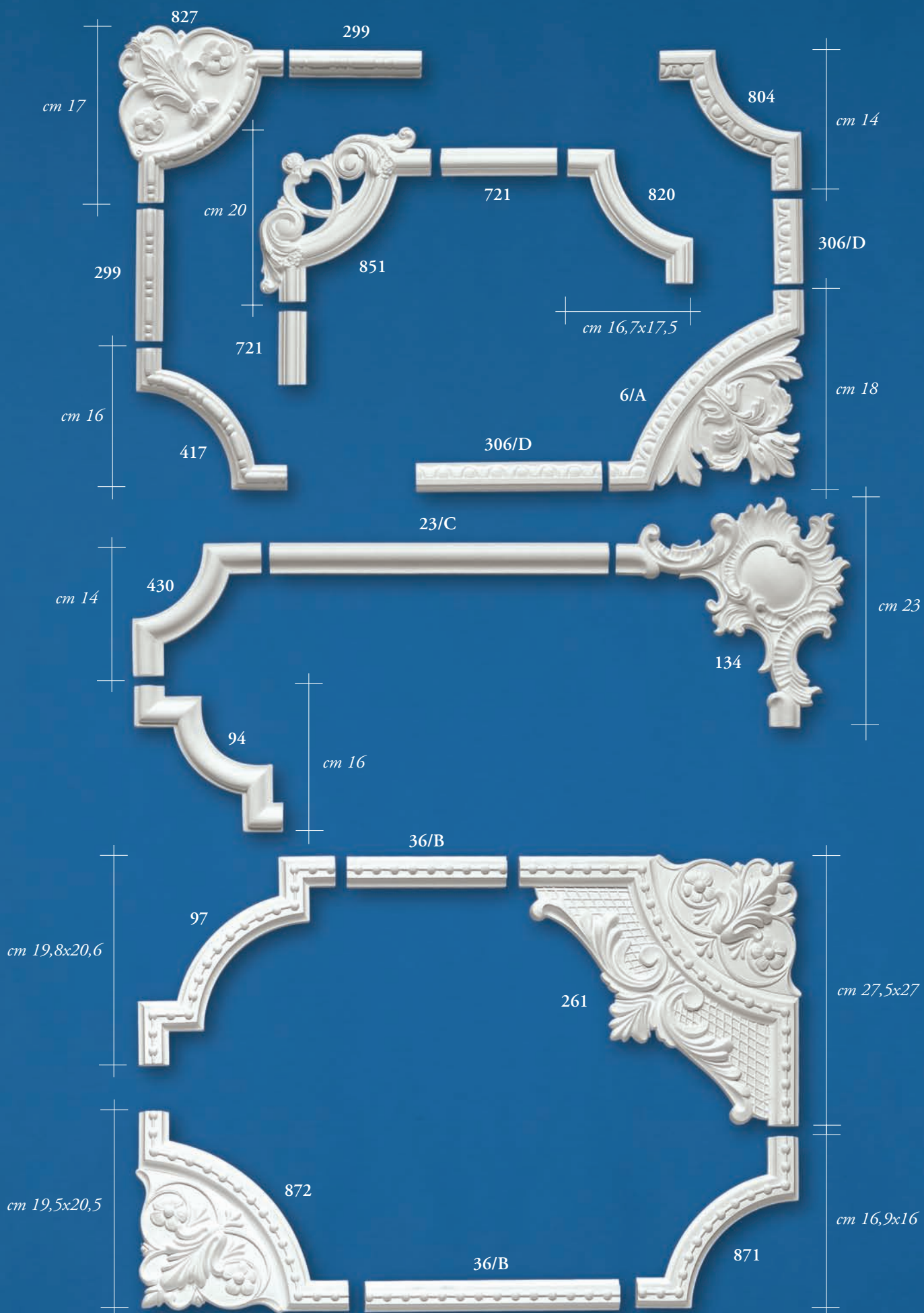





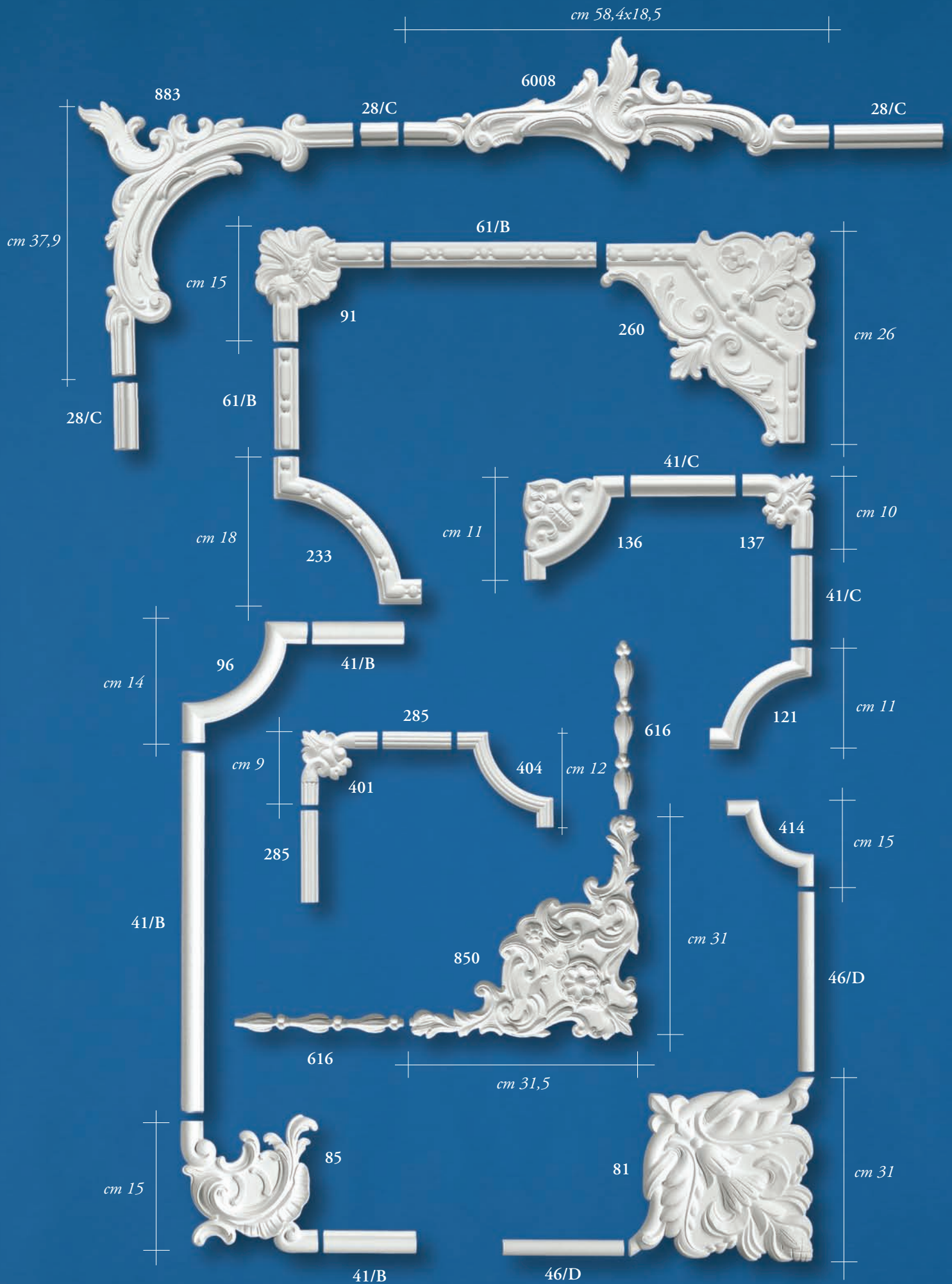



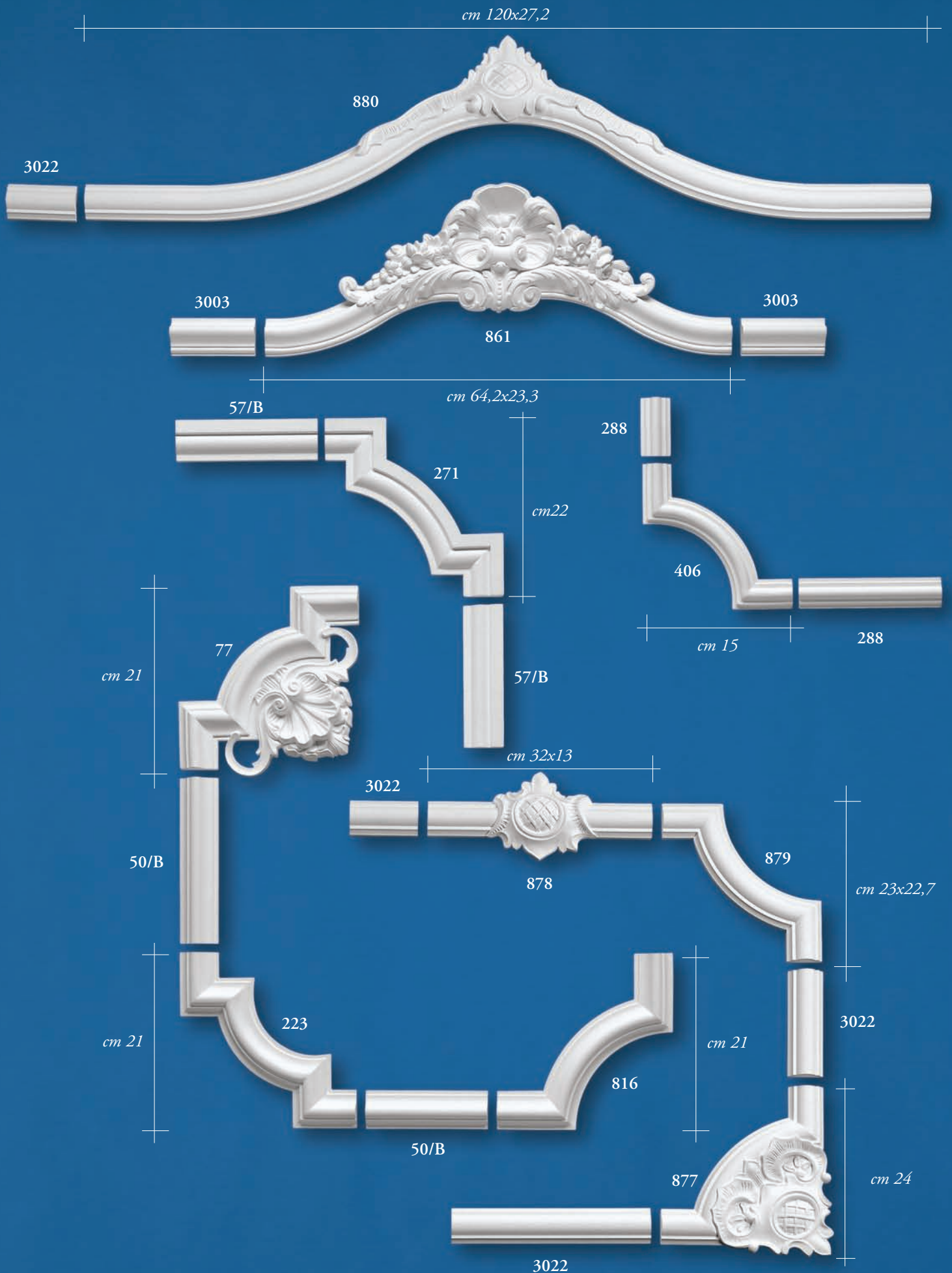

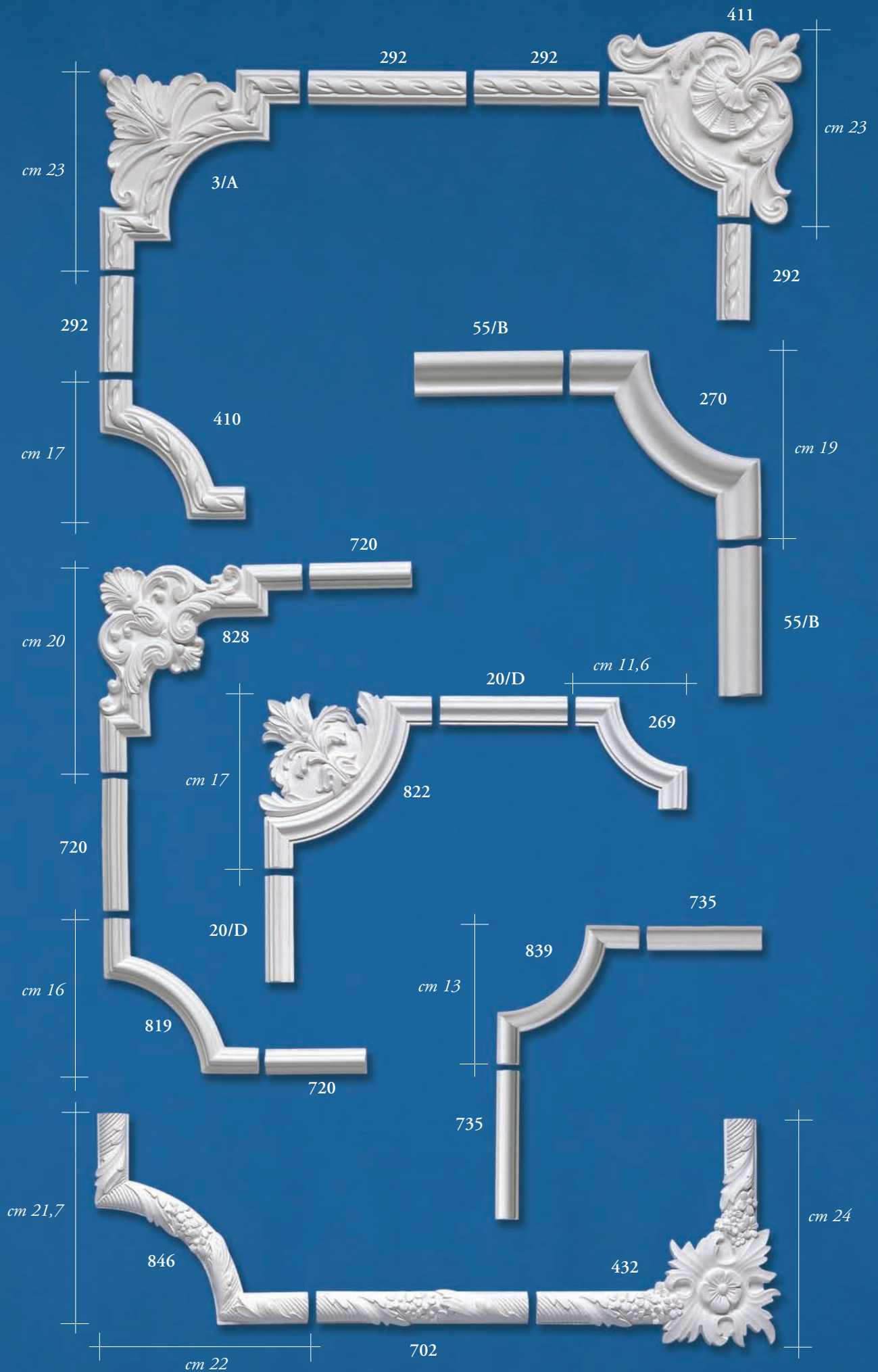

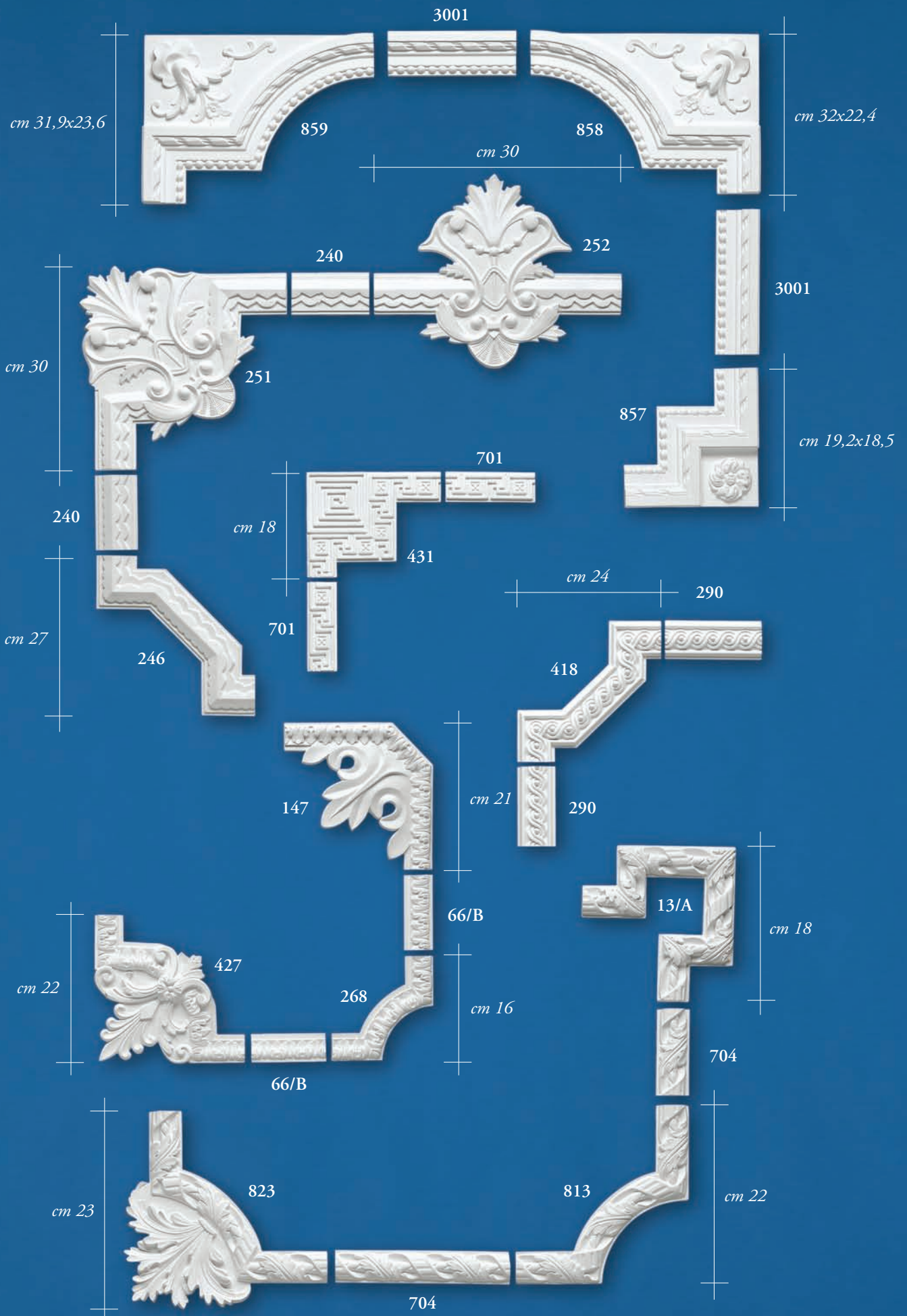



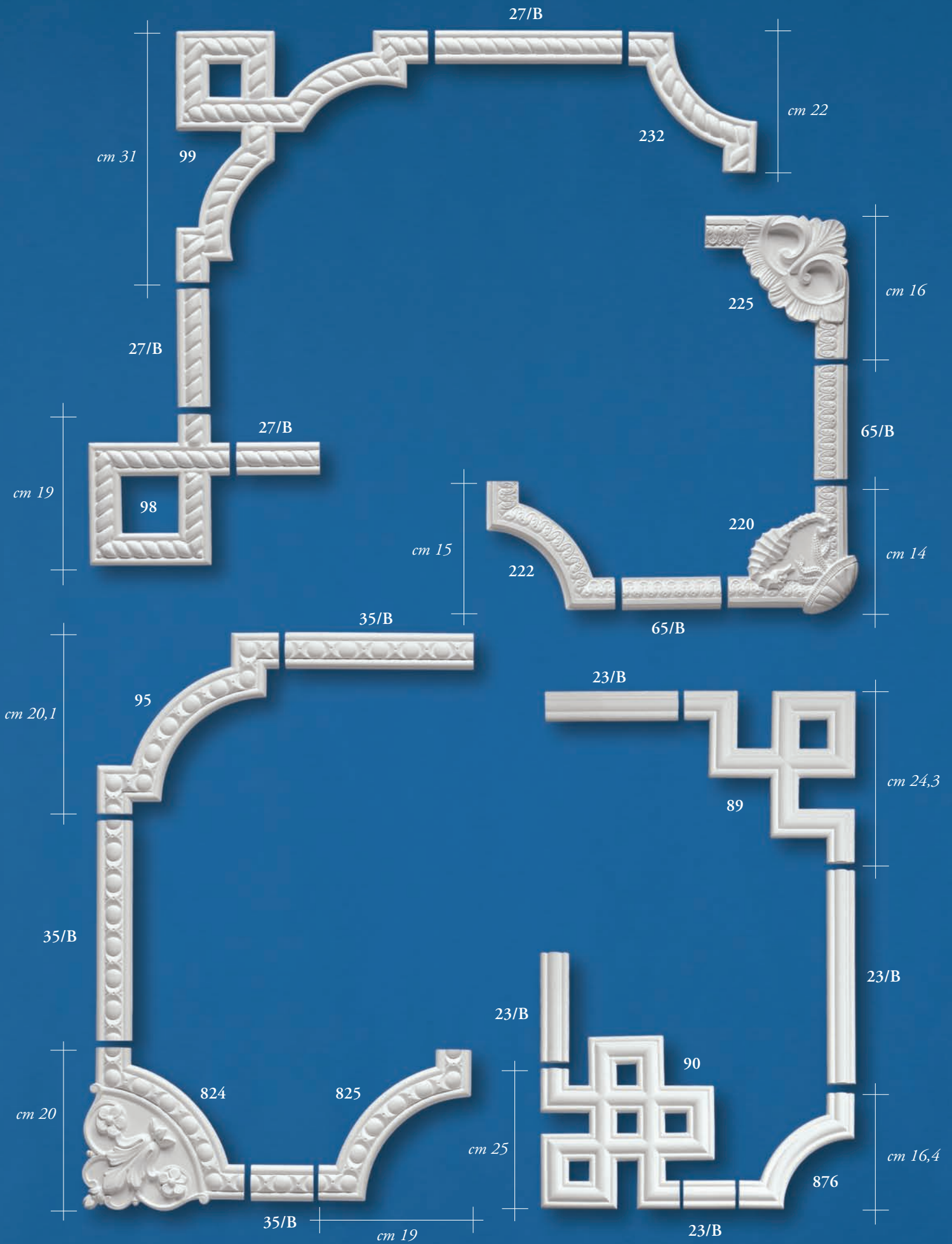

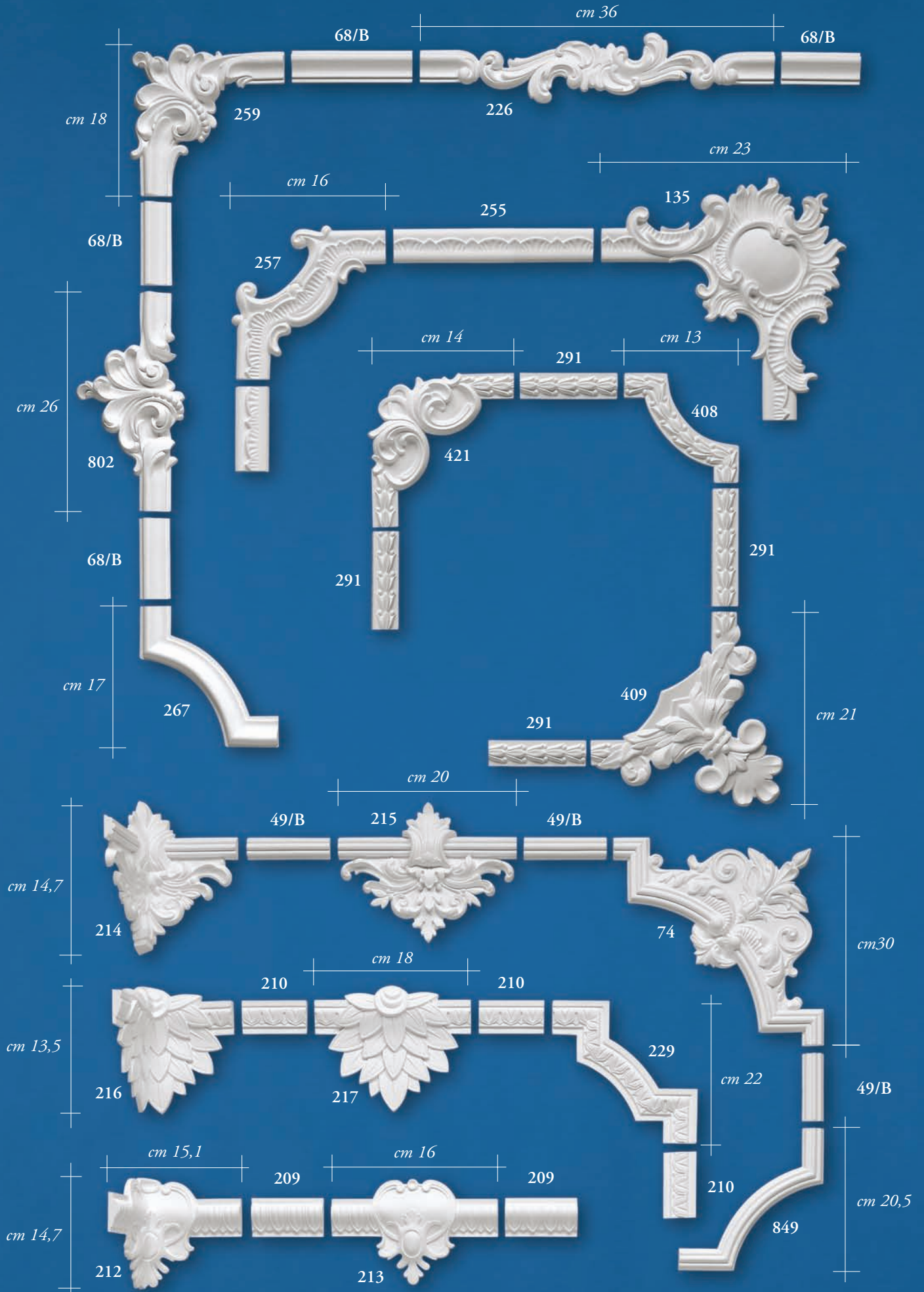



38/B

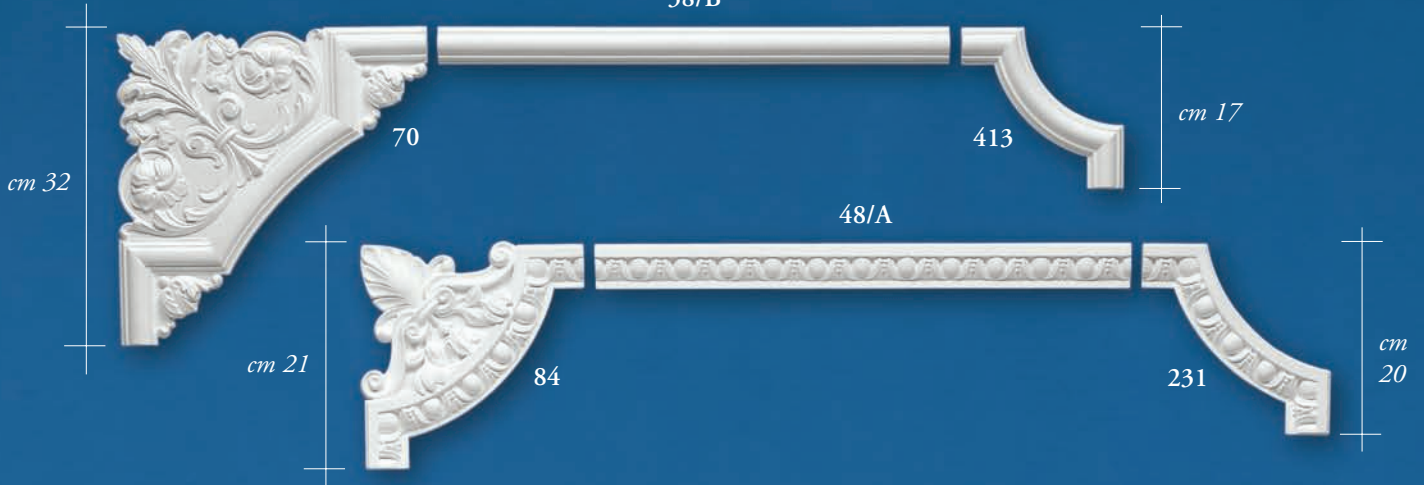

24/B

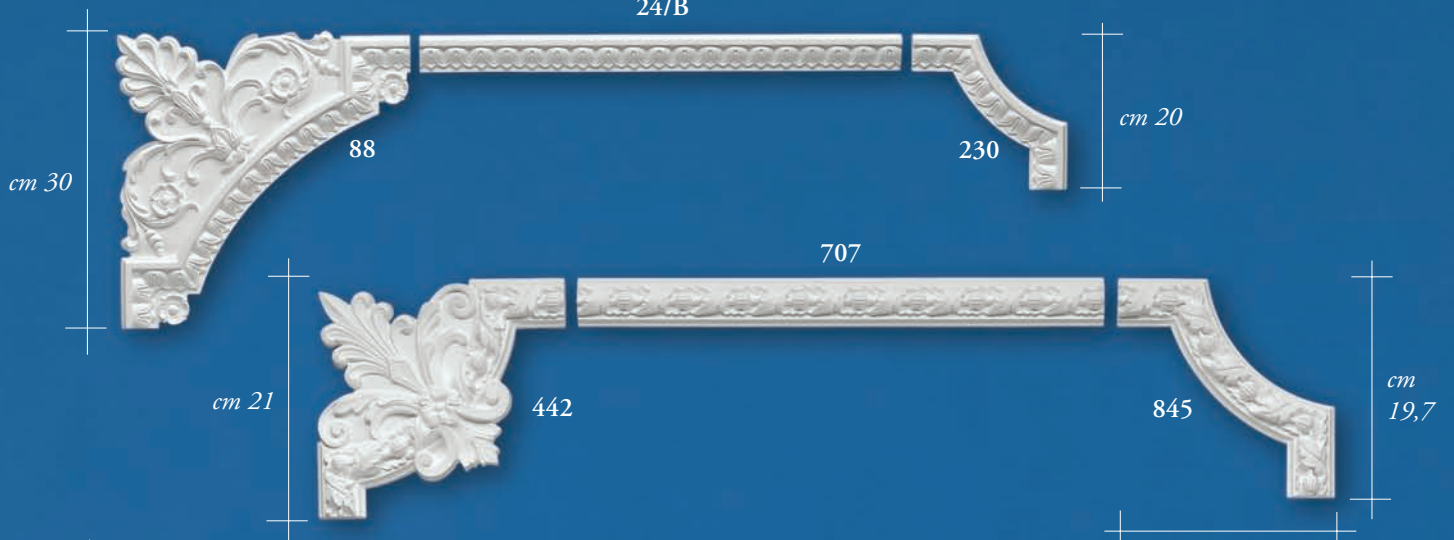

277

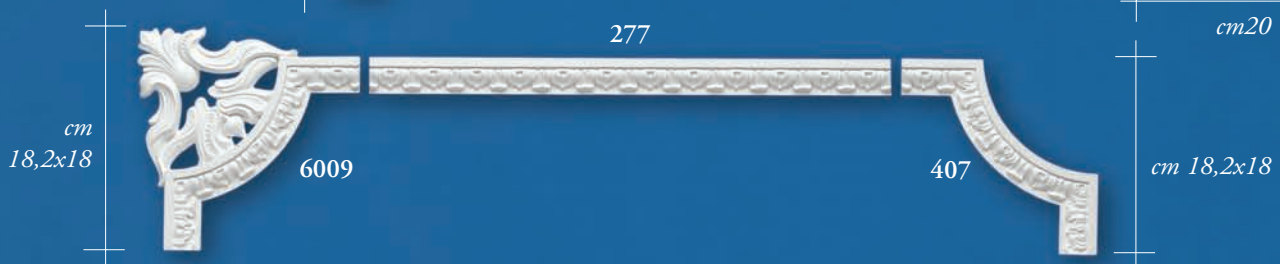

706

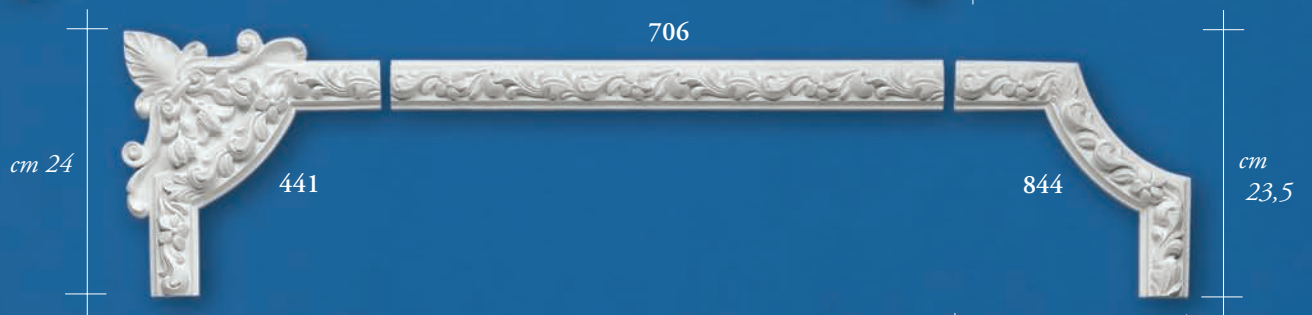

284

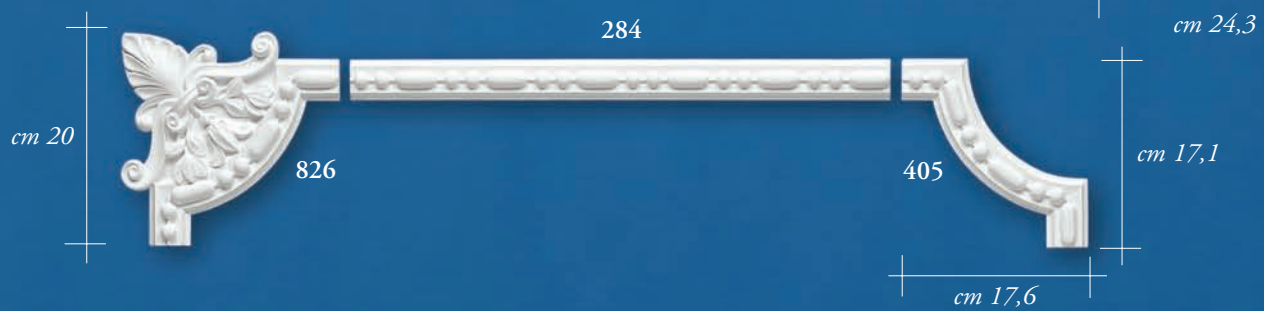



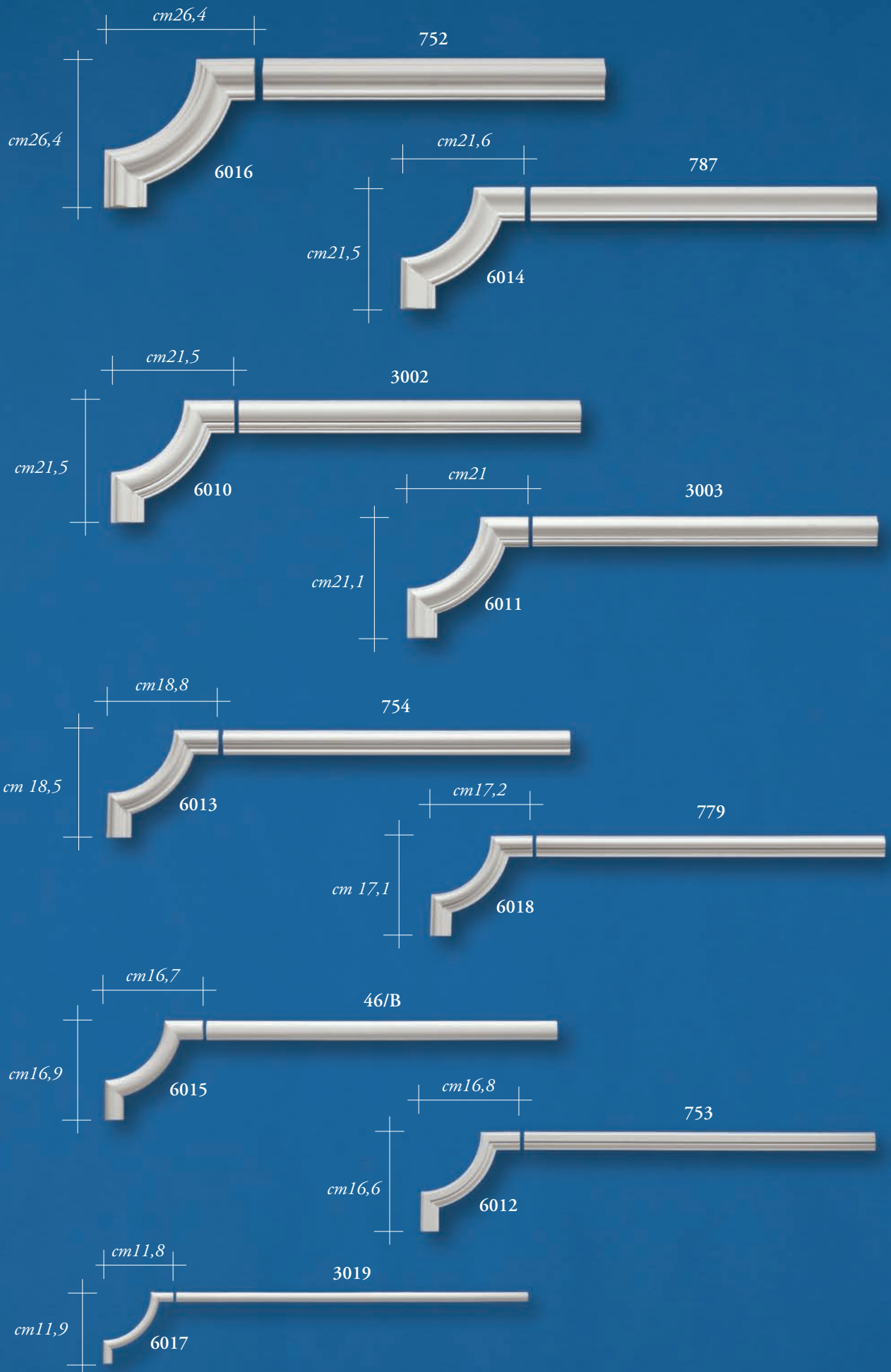

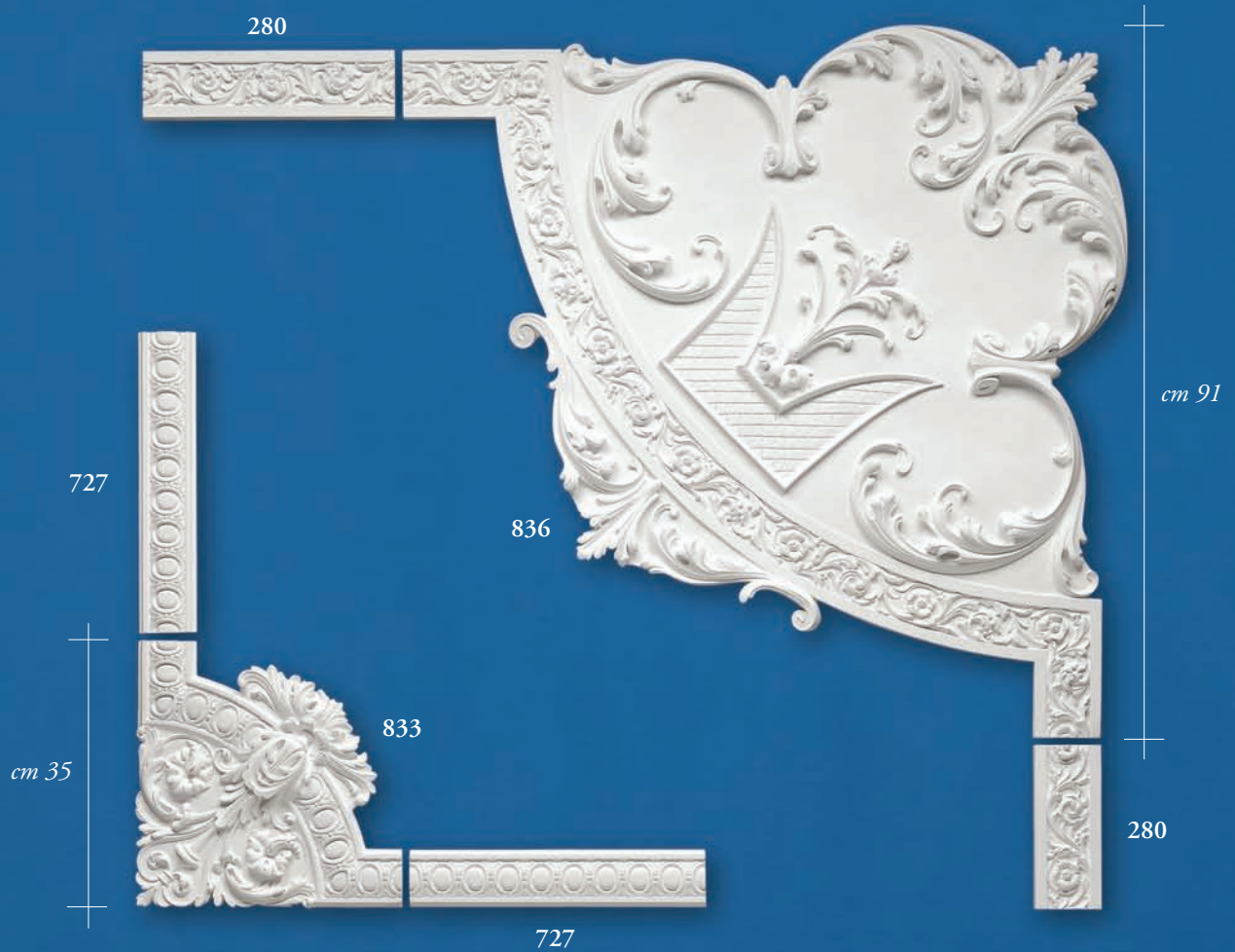

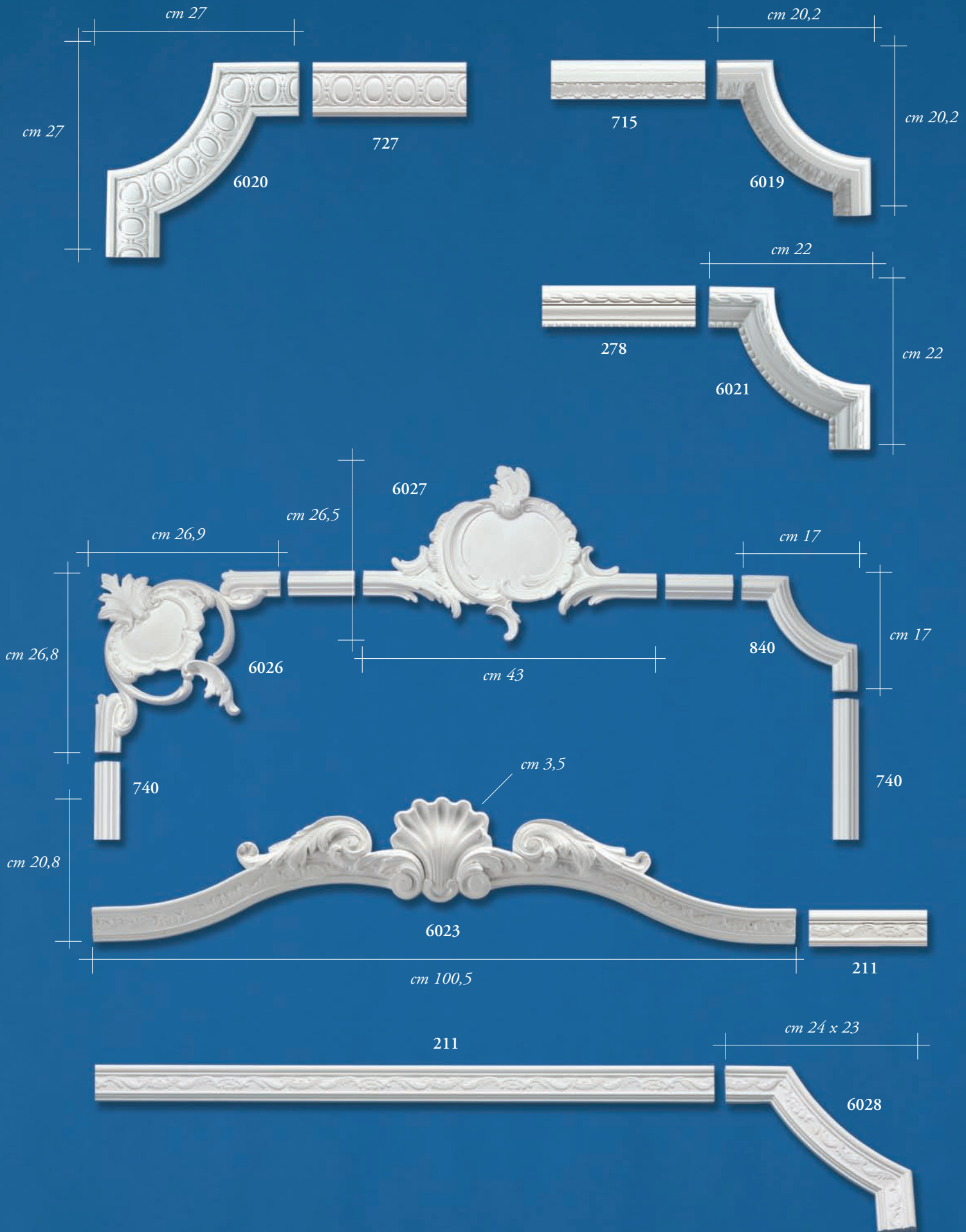



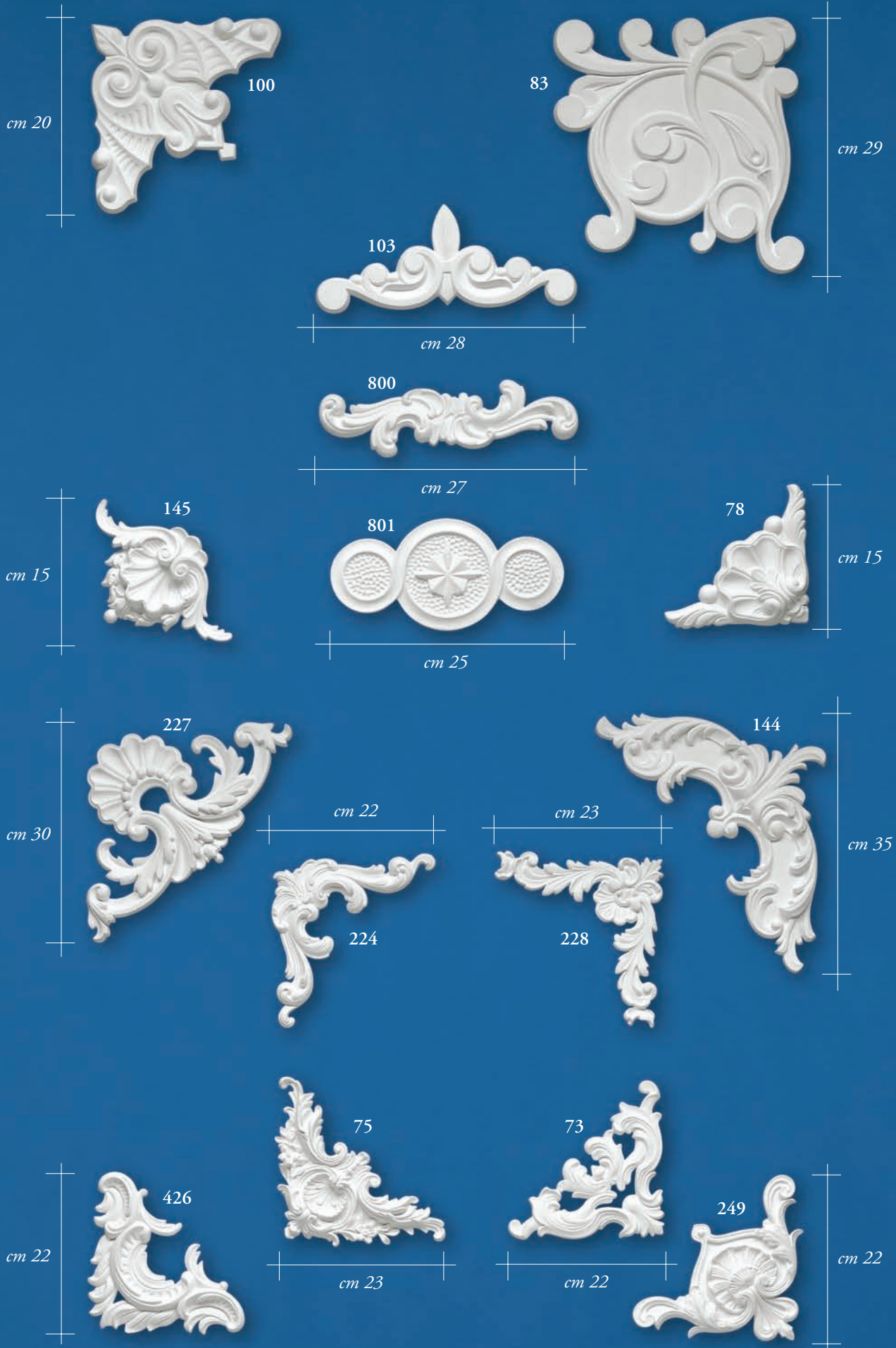



892

cm 60,3

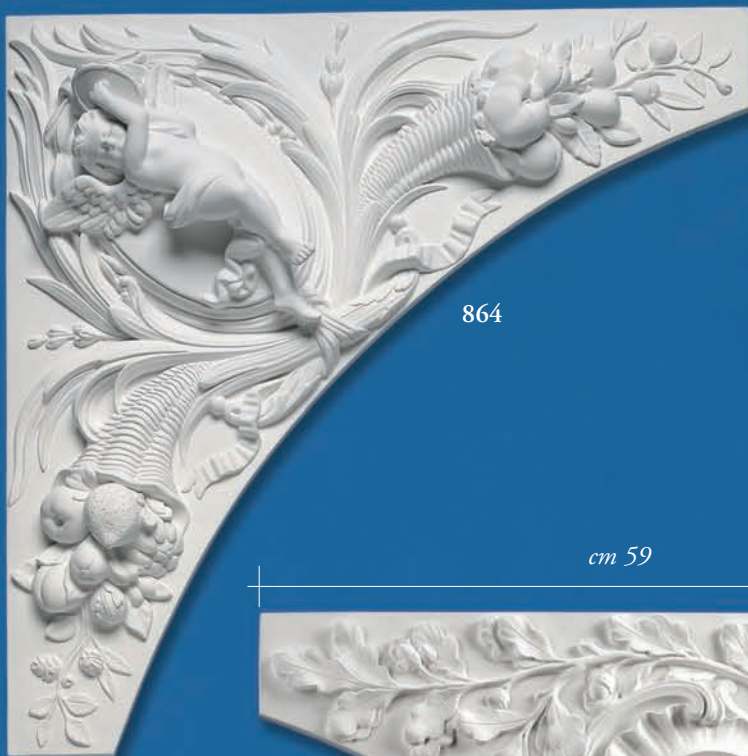

864

cm 60,2

cm 8,5

cm 59



6022

cm 58,8



101/L

cm 55

cm 8,5







lunghezza barre 150 cm

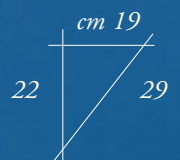
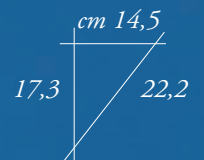
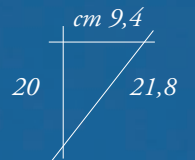
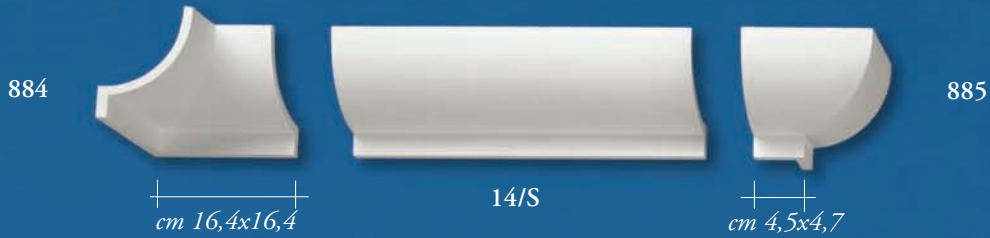
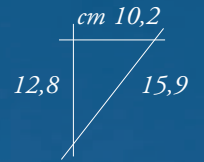
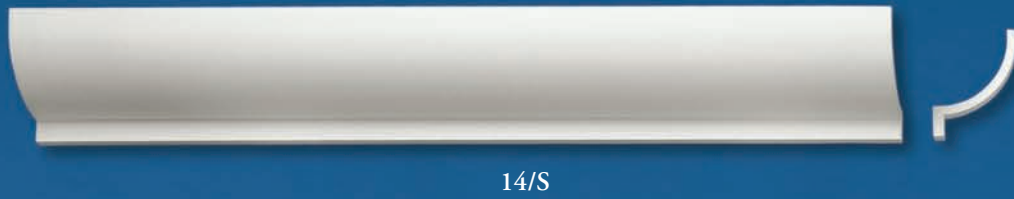

lunghezza barre 150 cm



6/S

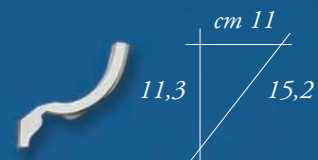

4/S

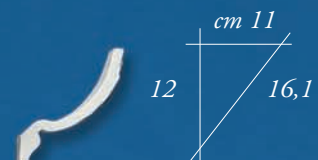

1/S

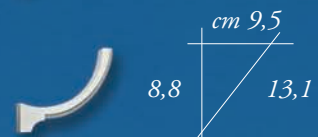

2/S

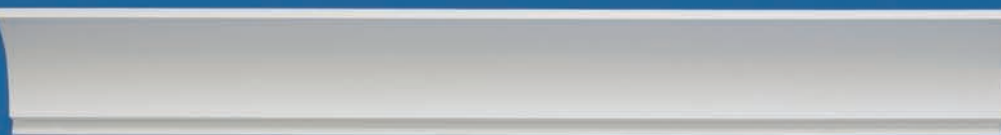
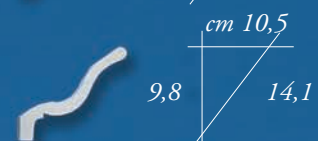

15/S

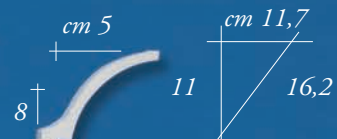

11/S

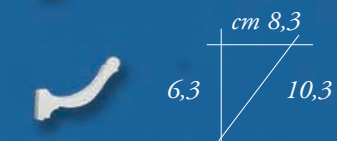

4/S

cm 17

cm 6,8x3,8

412

429

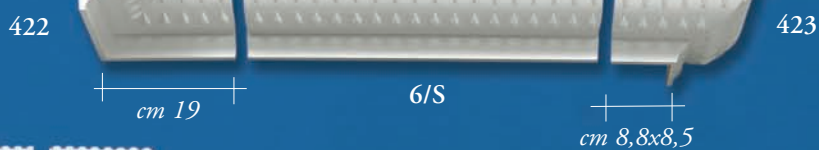

6/S

cm 19

cm 8,8x8,5

422

423

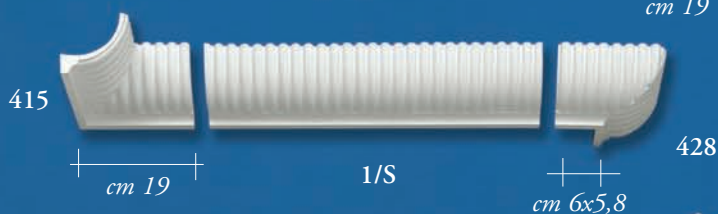

1/S

cm 19

cm 6x5,8

415

428



2/S

cm 17

cm 7,8x7,6

419

420



11/S

cm 13

cm 6,4x6

837

838



1002 A cm 25 B 22,8 C 12,5



19 A cm 31 B 27 C 9,5



140 A cm 26 B 23 C 14



1001 A cm 35 B 17,5 C 12,5



416 A cm 34,5 B 20,5 C 10



138 A cm 21,5 B 22 C 12



1000 A cm 28 B 14,2 C 13,8





1019 A cm 74 B 9,8 C 19,8



1020 A cm 74 B 9,8 C 19,8



1017 A cm 44,5 B 11,5 C 16,8



1022 A cm 27,5 B 14,4 C 15,6



1016 A cm 23,6 B 10,4 C 11,2



1021 A cm 28 B 14,4 C 14



1015 A cm 44,5 B 11,5 C 16,8



1010 A cm 32 B 18 C 18,3



1008 A cm 41,5 B 16,5 C 17



1009 A cm 34,5 B 21,5 C 18,5





1012 A cm 43 B 18 C 27,5



1013 A cm 45 B 15 C 29



1011 A cm 43 B 13,5 C 21,7



1014 A cm 41,5 B 14,7 C 20,4



1023 A cm 30 B 19,5 C 19



1003 A cm 30 B 19,5 C 19



1007 A cm 21,8 B 23



1005 A cm 21,8 B 23

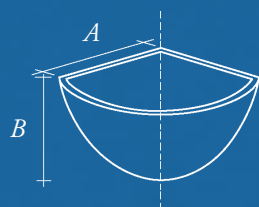

1024 A cm 16,8 B cm 14



1025 A cm 16,8 B cm 14

1004 A cm 41,5 B 22,5 C 18



1006 A cm 41,5 B 22,5 C 18



1018 A cm 42 B 12,8 C 17,7









# RIVESTIMENTO PER COLONNE

pilastres • coating for coloumns • säulenverkleidung • kolommen

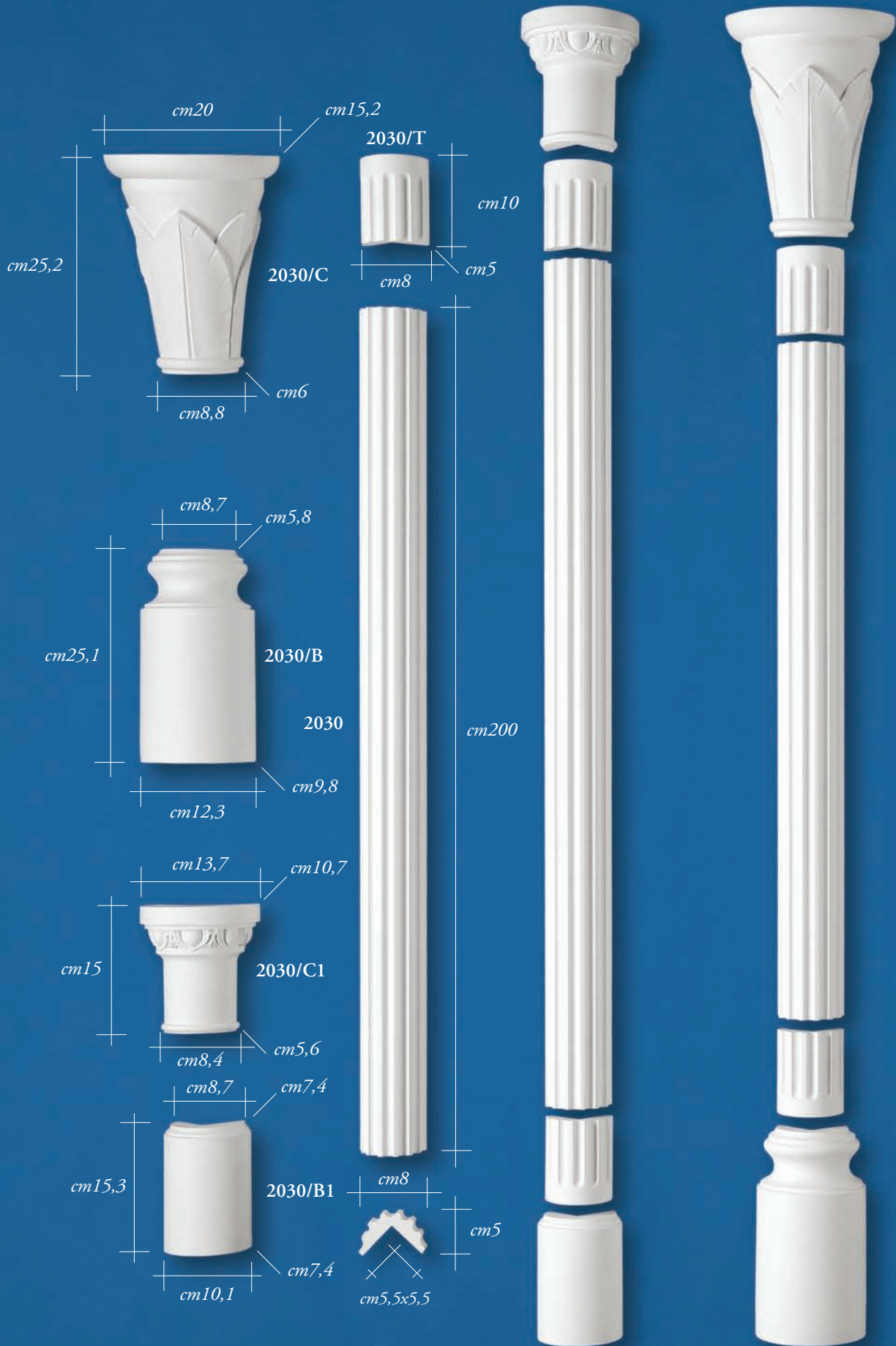

# RIVESTIMENTO PER COLONNE

pilastres • coating for coloumns • säulenverkleidung • kolommen

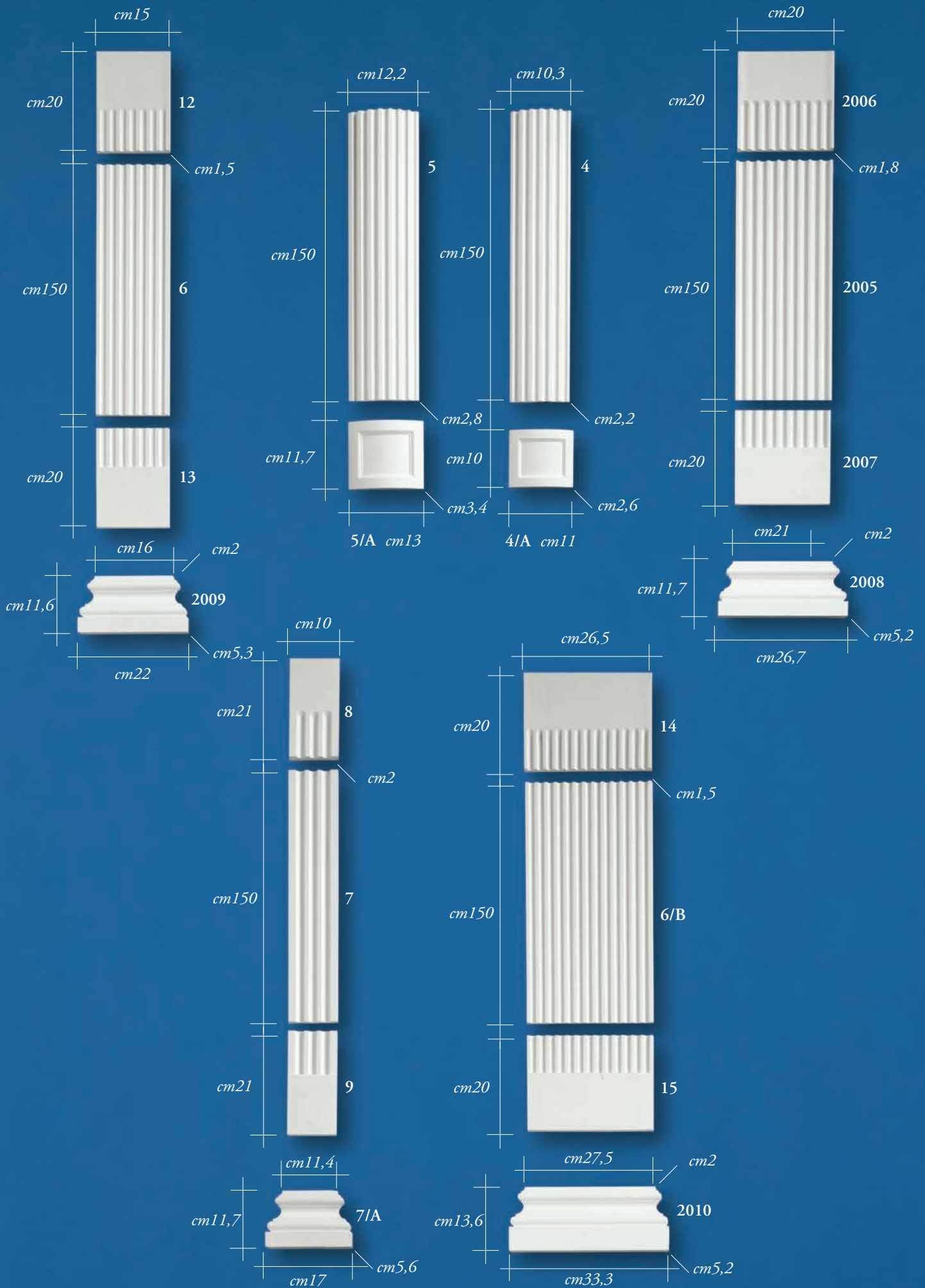

# RIVESTIMENTO PER COLONNE

pilastres • coating for coloumns • säulenverkleidung • kolommen

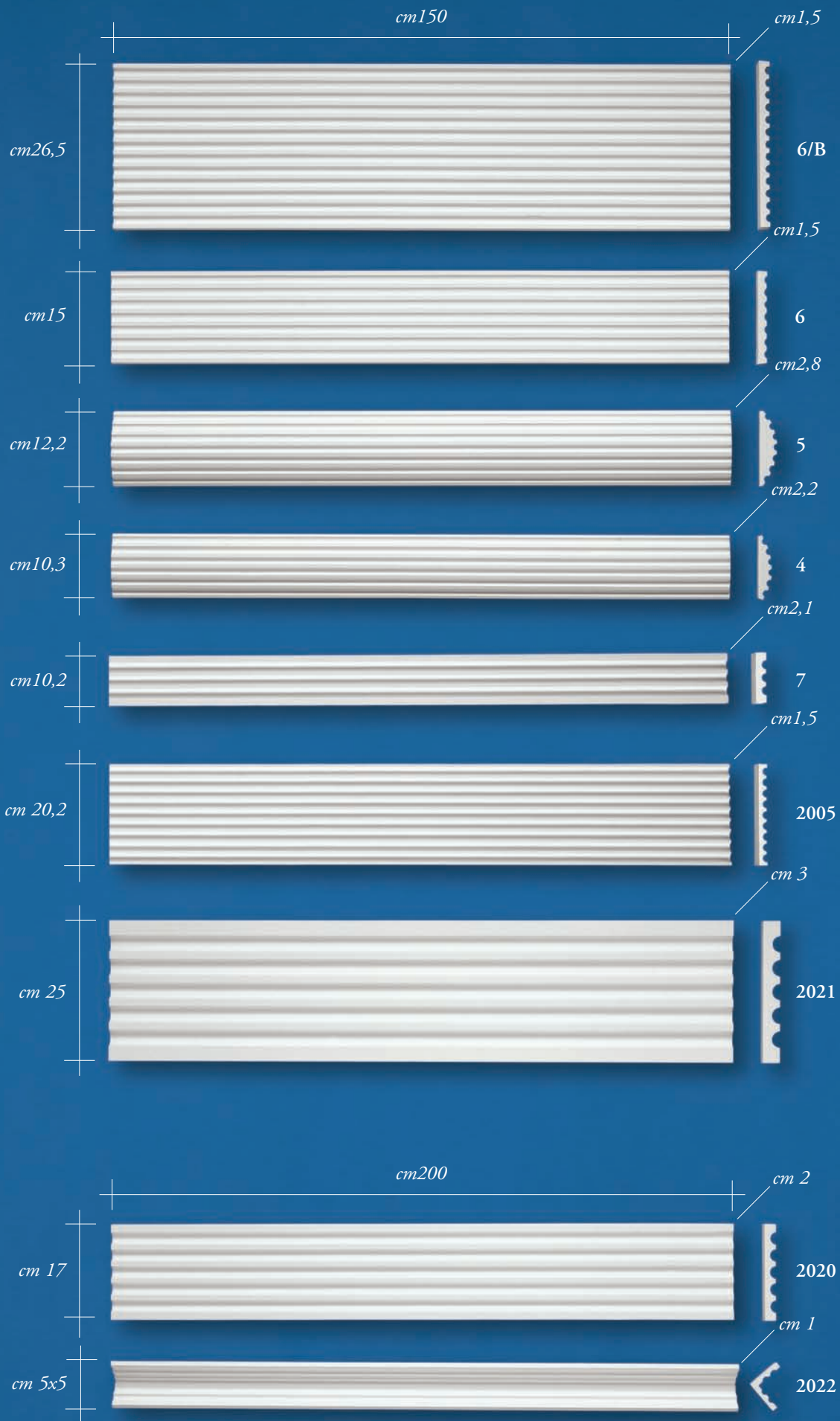



# RIVESTIMENTO PER COLONNE

pilastres • coating for coloumns • säulenverkleidung • kolommen

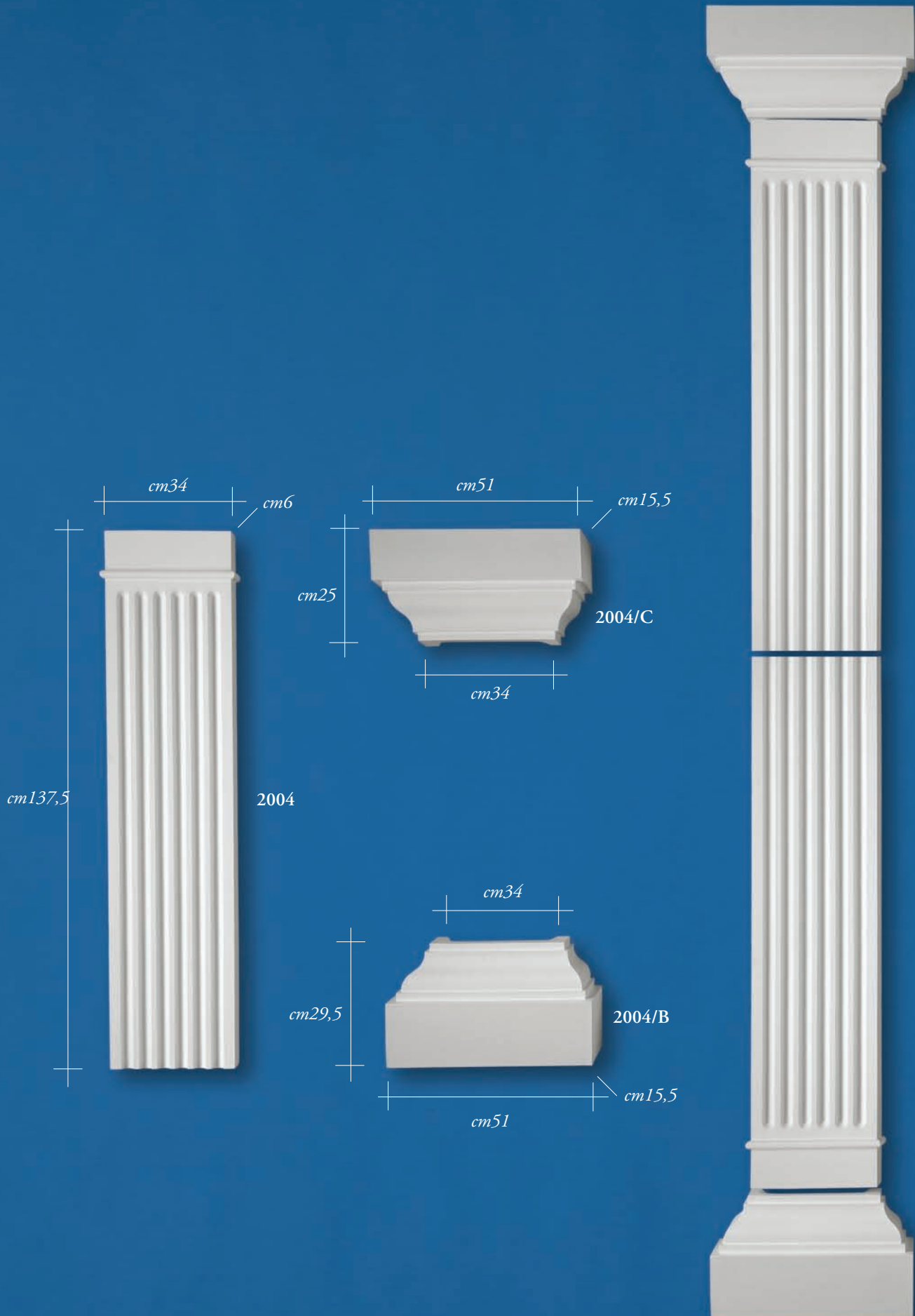

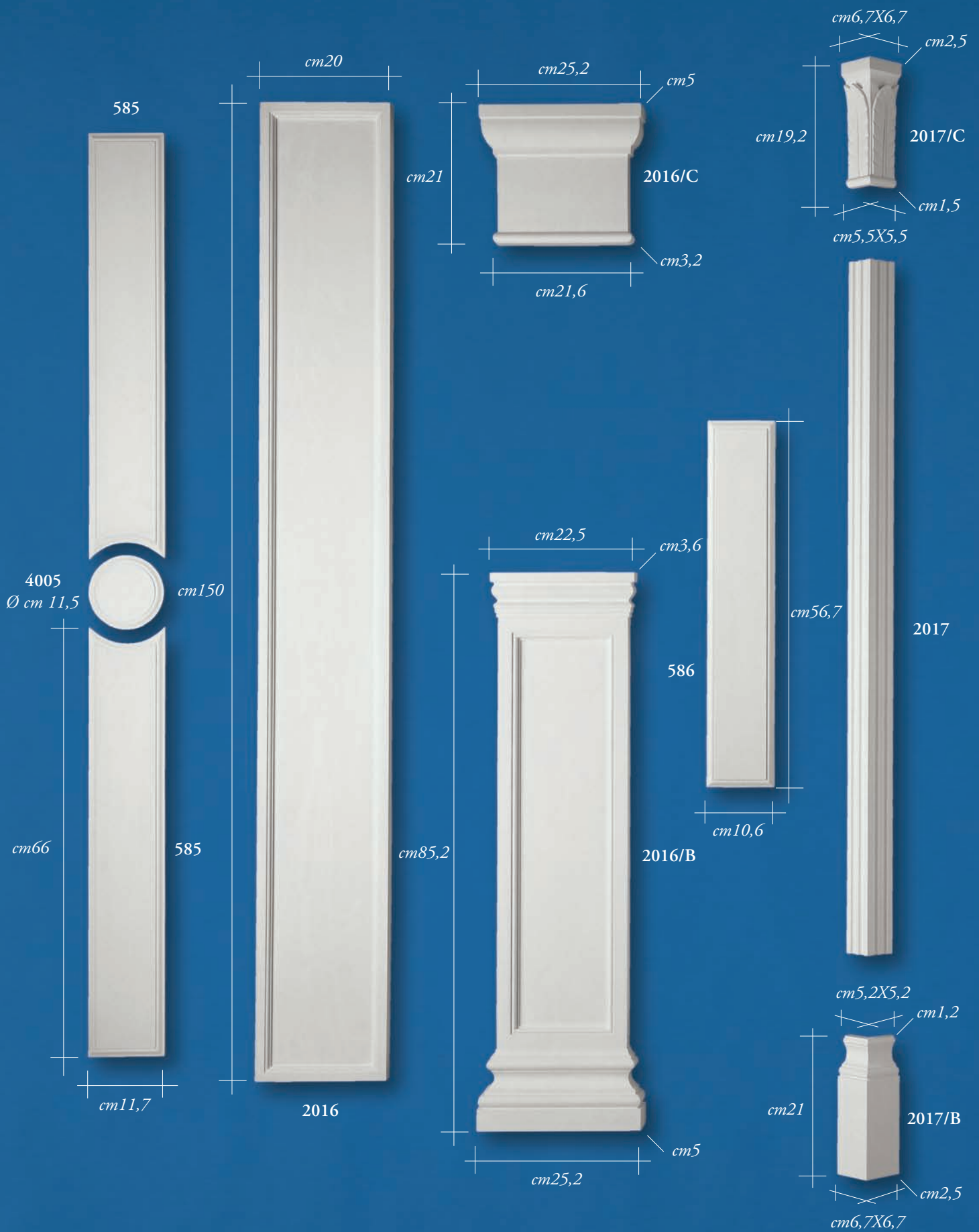

# RIVESTIMENTO PER COLONNE

pilastres • coating for coloumns • säulenverkleidung • kolommen

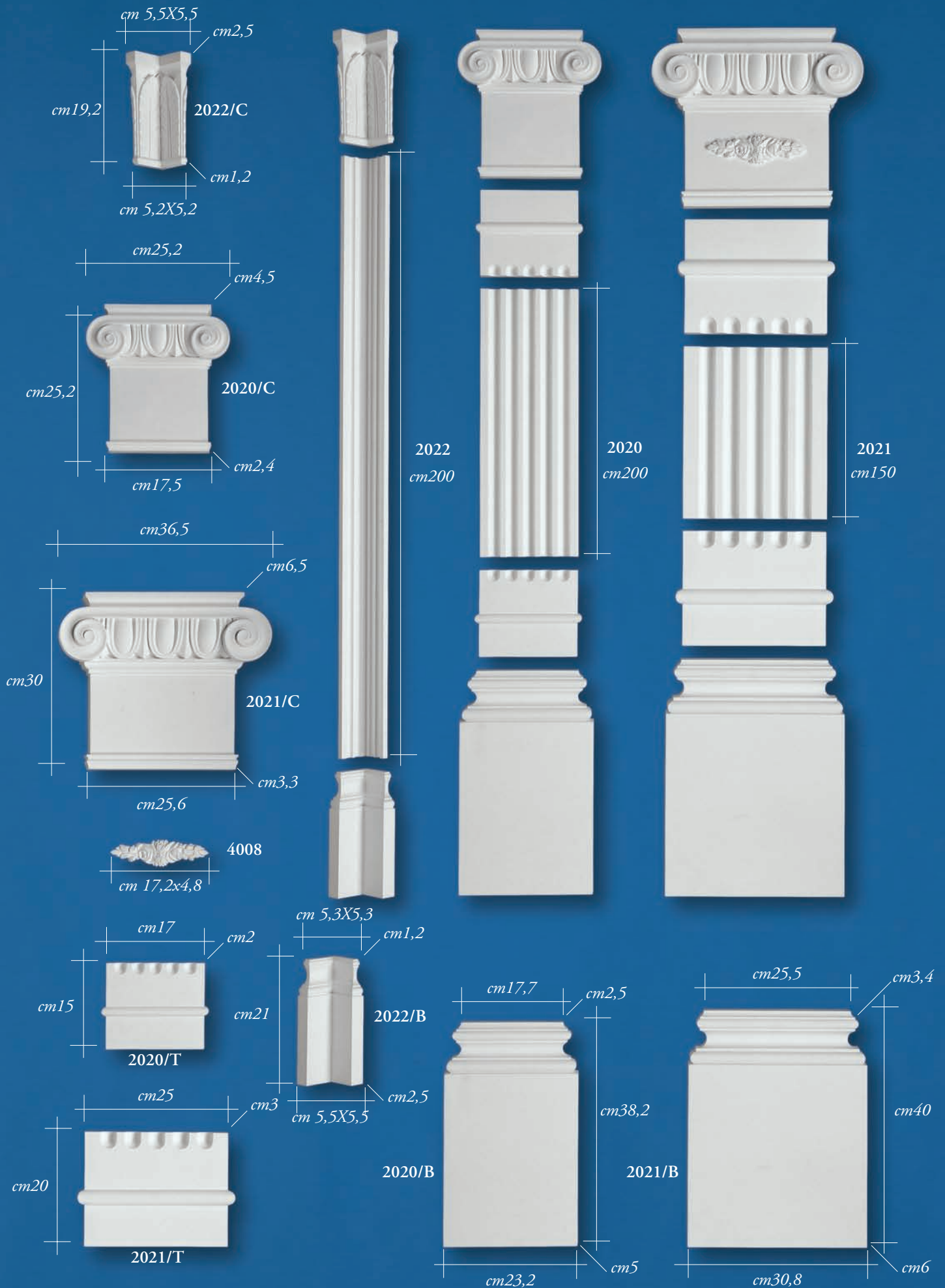











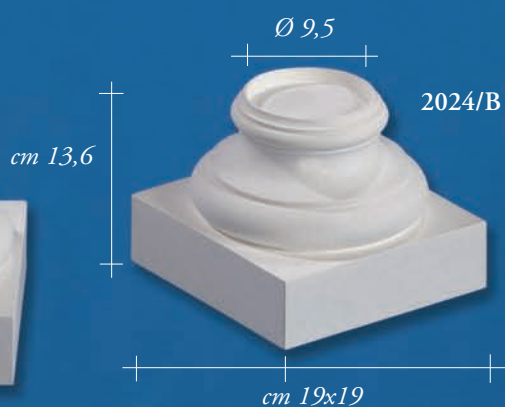
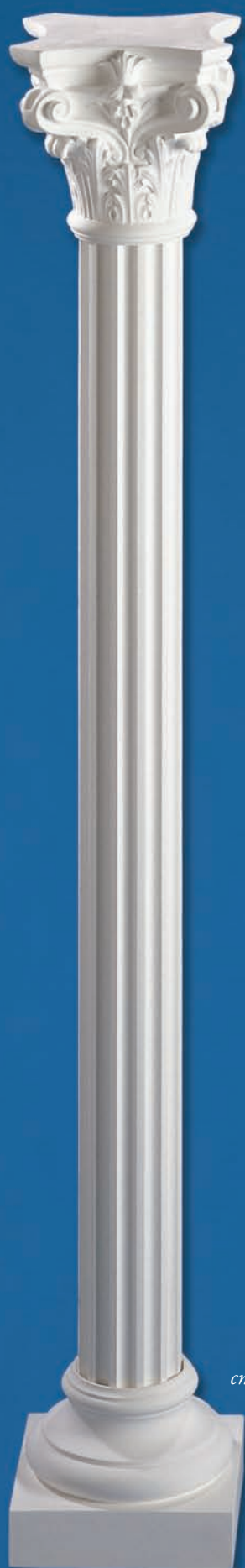



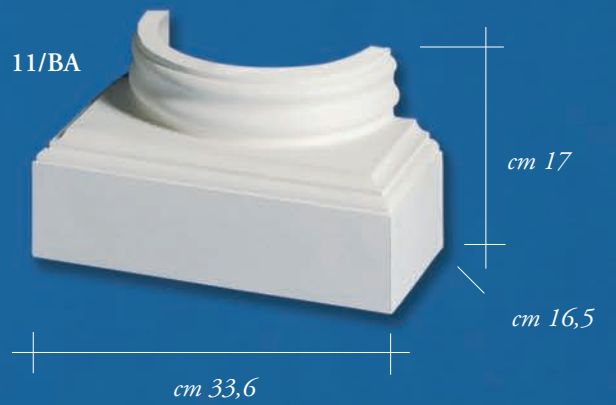
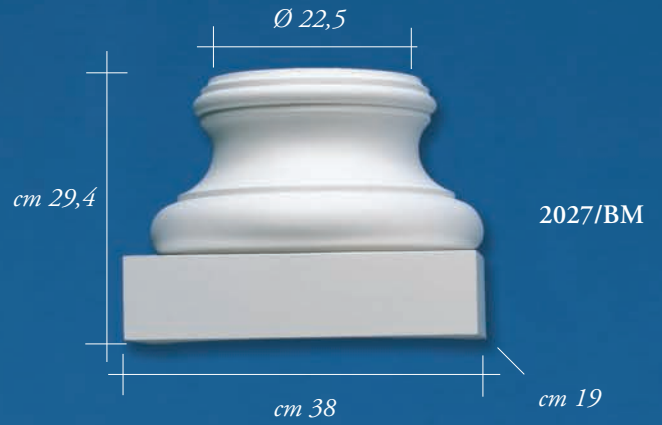













RIVESTIMENTO PER CAMINI

habillage chemines • fire surrounds • Kamin • chemines



RIVESTIMENTO PER CAMINI

habillage chemines • fire surrounds • Kamin • chemines





# RIVESTIMENTO PER CAMINI

habillage chemines • fire surrounds • Kamin • chemines



# RIVESTIMENTO PER CAMINI

habillage chemines • fire surrounds • Kamin • chemines











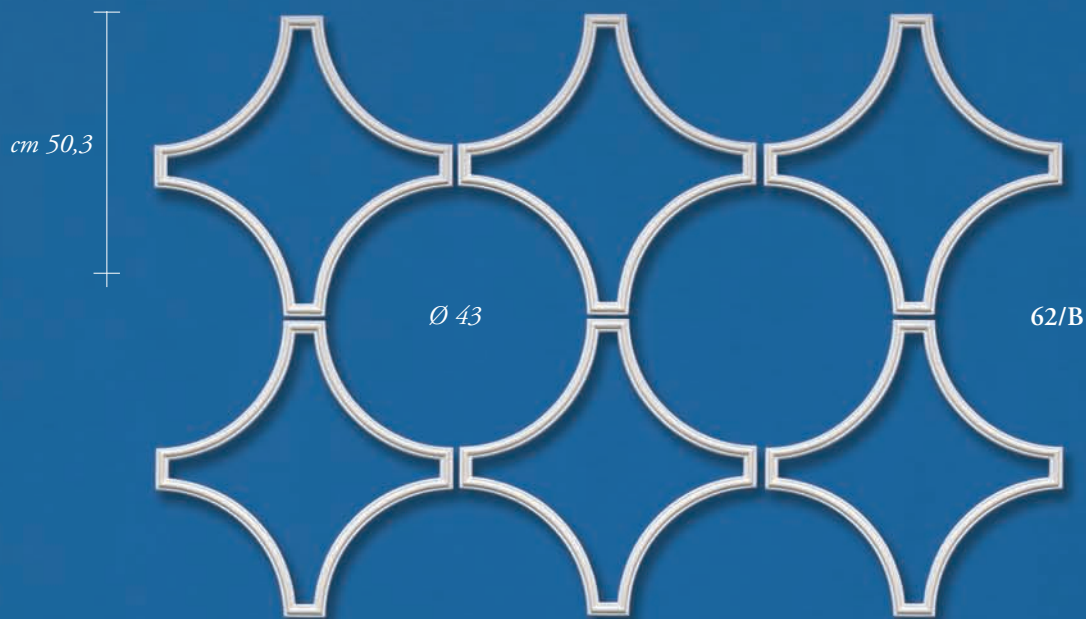





542 A cm 67  
B cm 36,5  
C cm 15



562 A cm 56  
B cm 28  
C cm 9,5

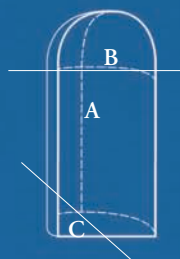

546 A cm 78  
B cm 47  
C cm 22,5



547 A cm 64,5  
B cm 36,5  
C cm 17





cm 26

563



cm 107,5

cm 40,5

552



cm 119,5

cm 26,2

5003



cm 9

cm 3,1

cm 124,2

cm 30,2



5002

cm 137

cm 44,6

565



cm 146







592 cm 56,8x35,5



591 cm 57x31,3



571 cm 57,2x67,5



574 cm 56,2x66,5



570 cm 57,6x67,5



541 cm 59x69



564 cm 53x140





BPN2 Ø 40,2



BPN1 Ø 40,2



573 cm 36,2x26,4



566 cm 46x54



572 cm 36,5x26,8



543 cm 34x118



5001 cm 21,6x69



553 cm 38,8x28,5



551 cm 72x51



556 cm 38,8x28,5



554 cm 38,8x28,5



561 Ø 18



560 Ø 18



559 Ø 18



555 cm 38,8x28,5



558 Ø 18



549 cm 81,5x66



550 cm 81,5x66





575 cm 21,8x12



577 cm 27,5x17



576 cm 22x13,5



4010 cm 28,5x18



5000 cm 92,9x56,6



MADONNA cm 43,8x36,2



272/S

cm 12x8,5



272/D

cm 12x8,5



598 cm 46,2x46,2



597 cm 56,6x22,2



599 cm 92,7x56,7



584 cm 56,7x56,7



5006

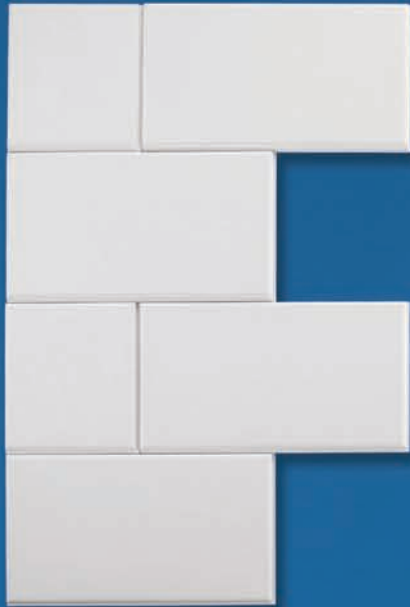
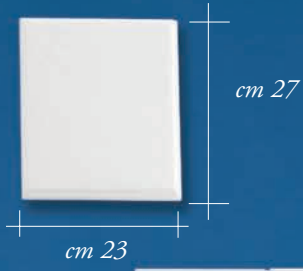

cm 27

5007



5006/S

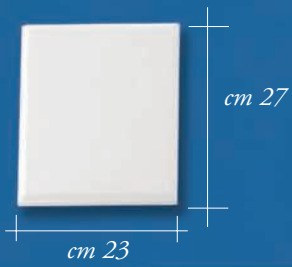

cm 27

5007/S





593 cm 99,5x17,2



594 cm 99x31,5



540 cm 99,2x27



590 cm 43,5x37,2



588 cm 43,5x37,2



578 Ø 45,5



589 cm 43,5x37,2



587 cm 43,5x37,2



544 cm 39x18,5



557 cm 39x18,5



545 cm 39x18,5



595 cm 35,4x90,5





101 cm 24,3x28,2



102 cm 32,7x18,5



103 Ø 44

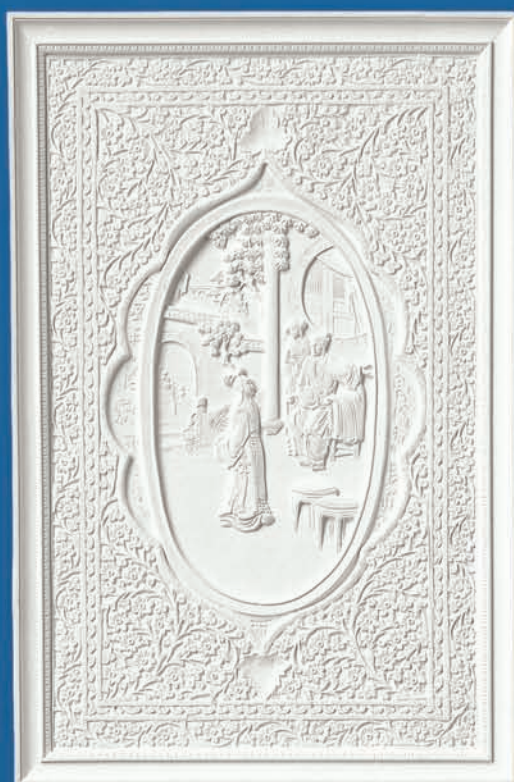

105 cm 60x39,4

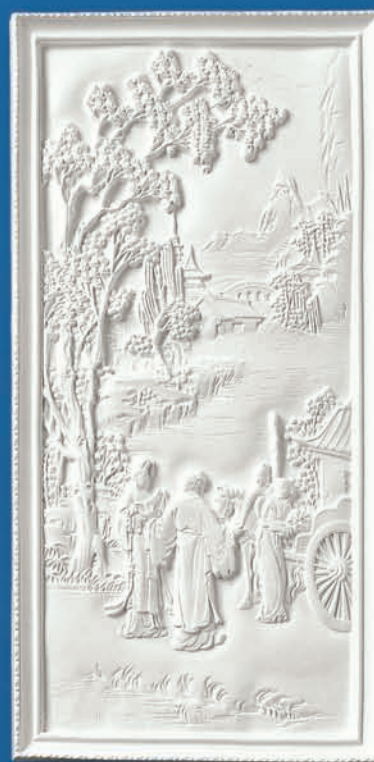

104 cm 58,5x28,6



567 cm 83x120



568 cm 77x128,2



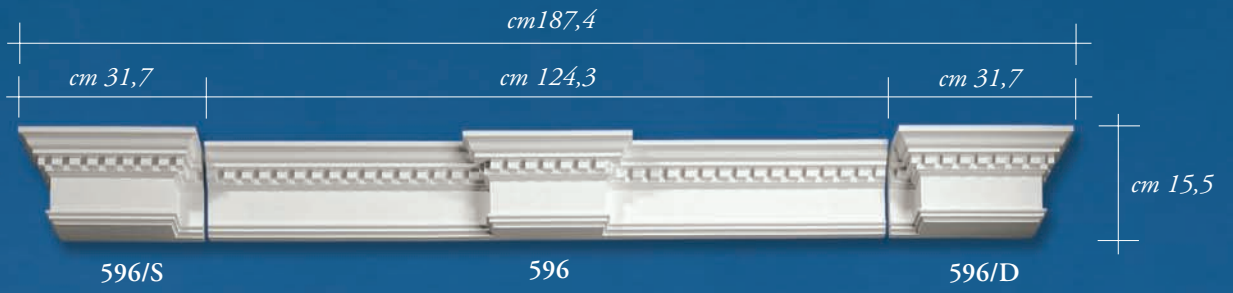

PENS 14





2023/D cm 63x33,1

2023/S cm 63x33,1

2023/D cm 63x33,1

536  
cm 24,3  
cm 6  
cm 19,3

535  
cm 15,1  
cm 6  
cm 10,2

2023 cm 12x9,3

536

3009

3009

535

2023 cm 12x9,3

2023/D cm 63x33,1

2023/S cm 63x33,1

3009

3009

3009

3009

2019

2019

2002 cm 25,5x32

2001/S cm 66,5x68

2001/D cm 66,5x68

750

750

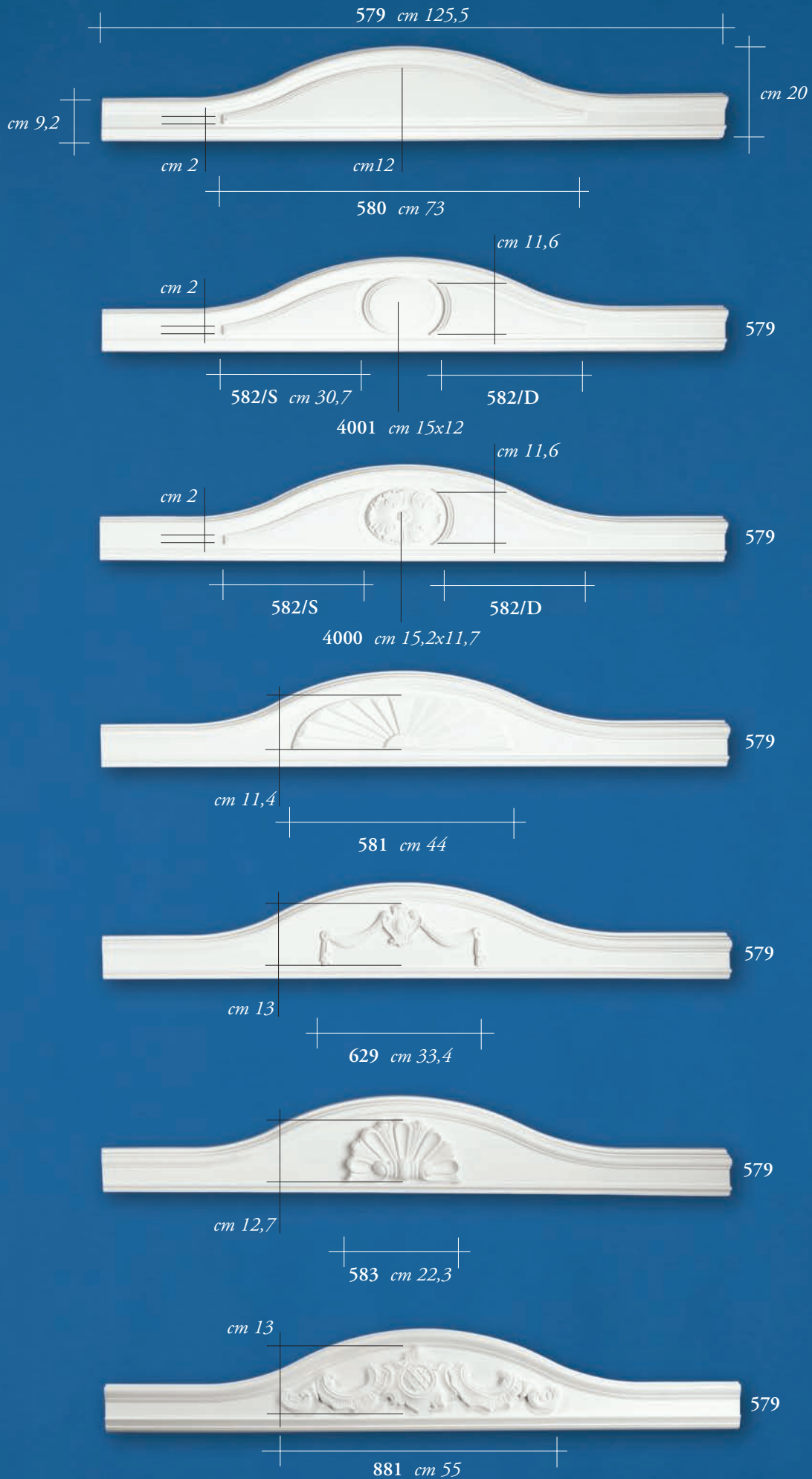

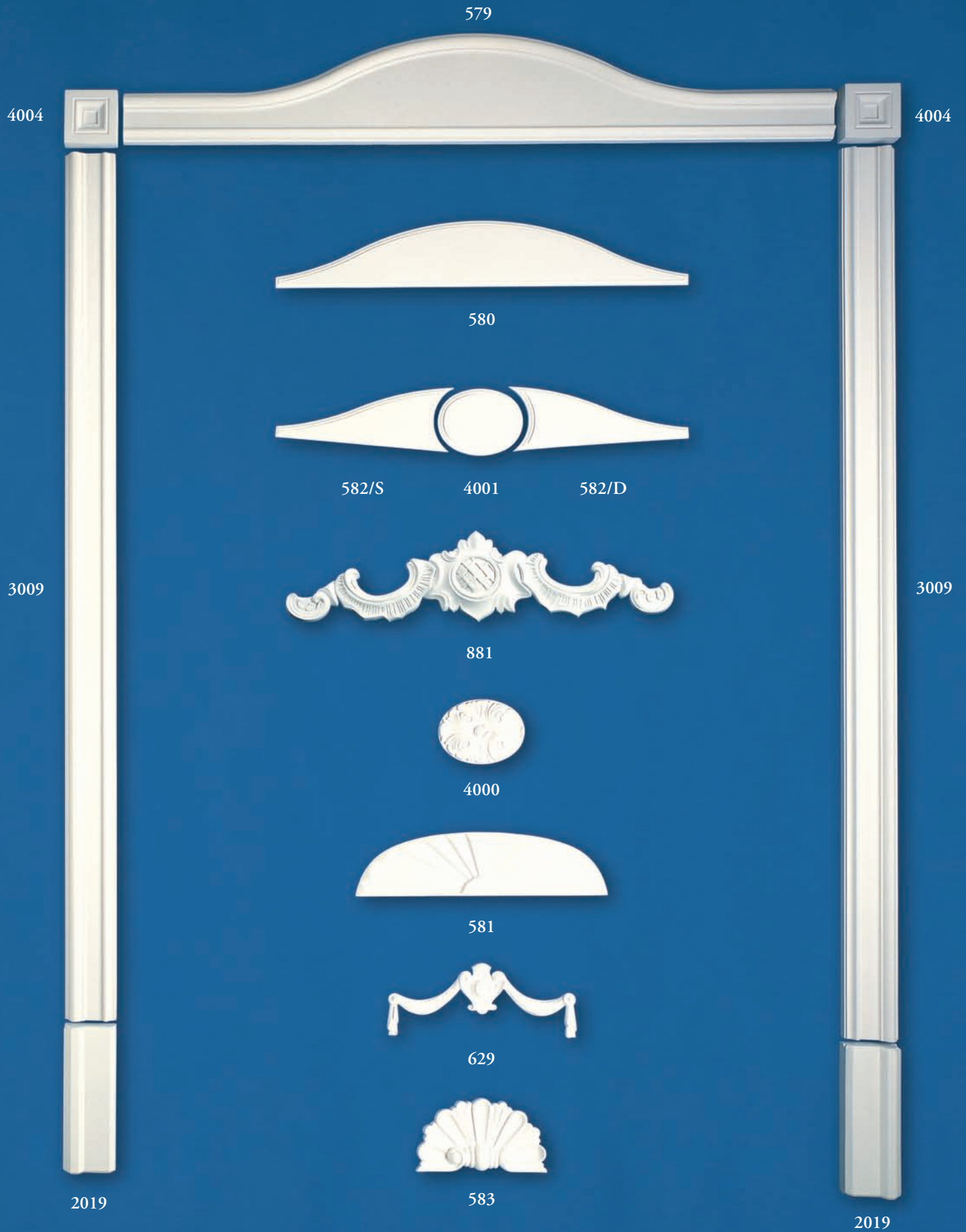



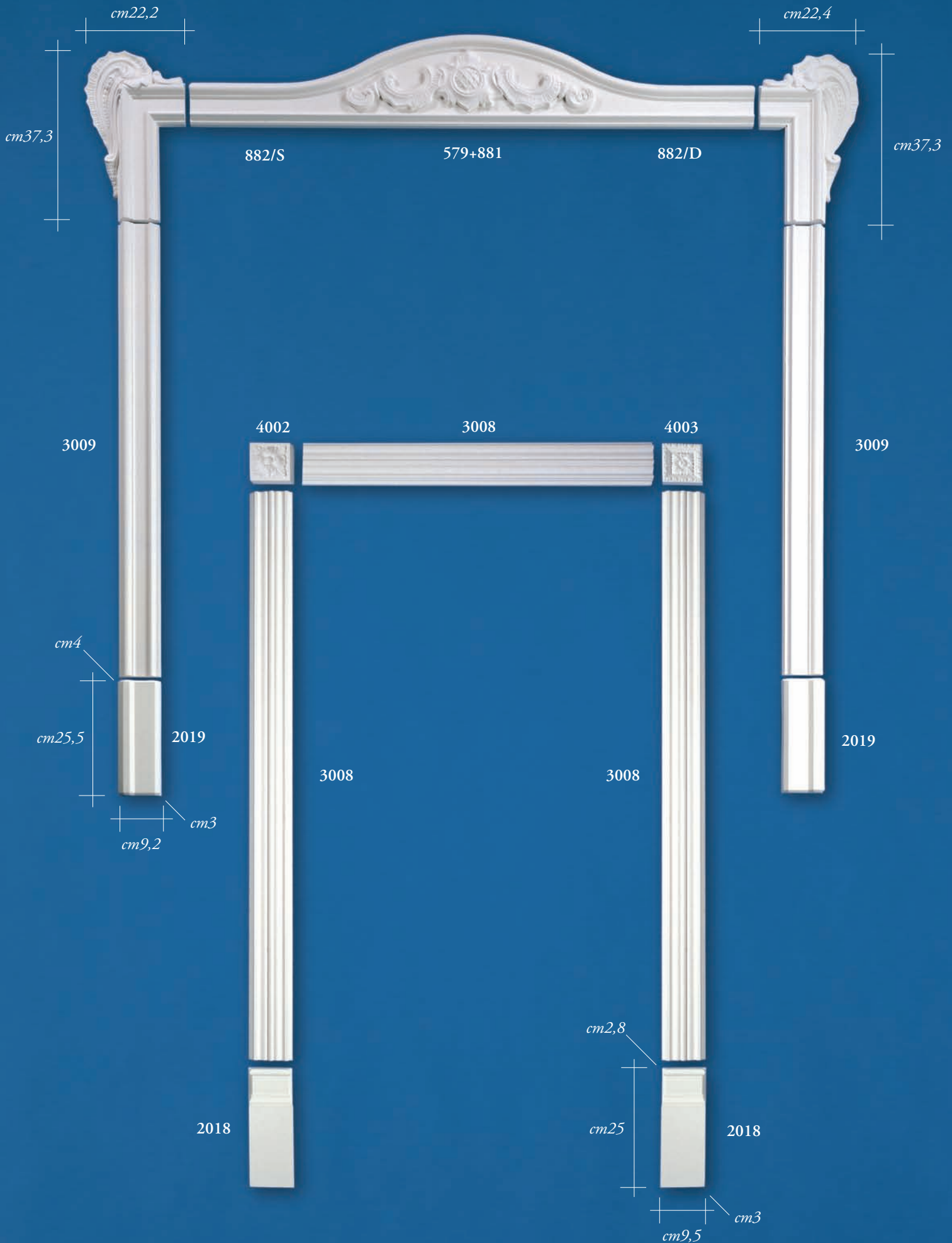

SOFFITTO BAROCCO

mouluures décorative • baroque ceiling • decke im barokstil • baroklijsten

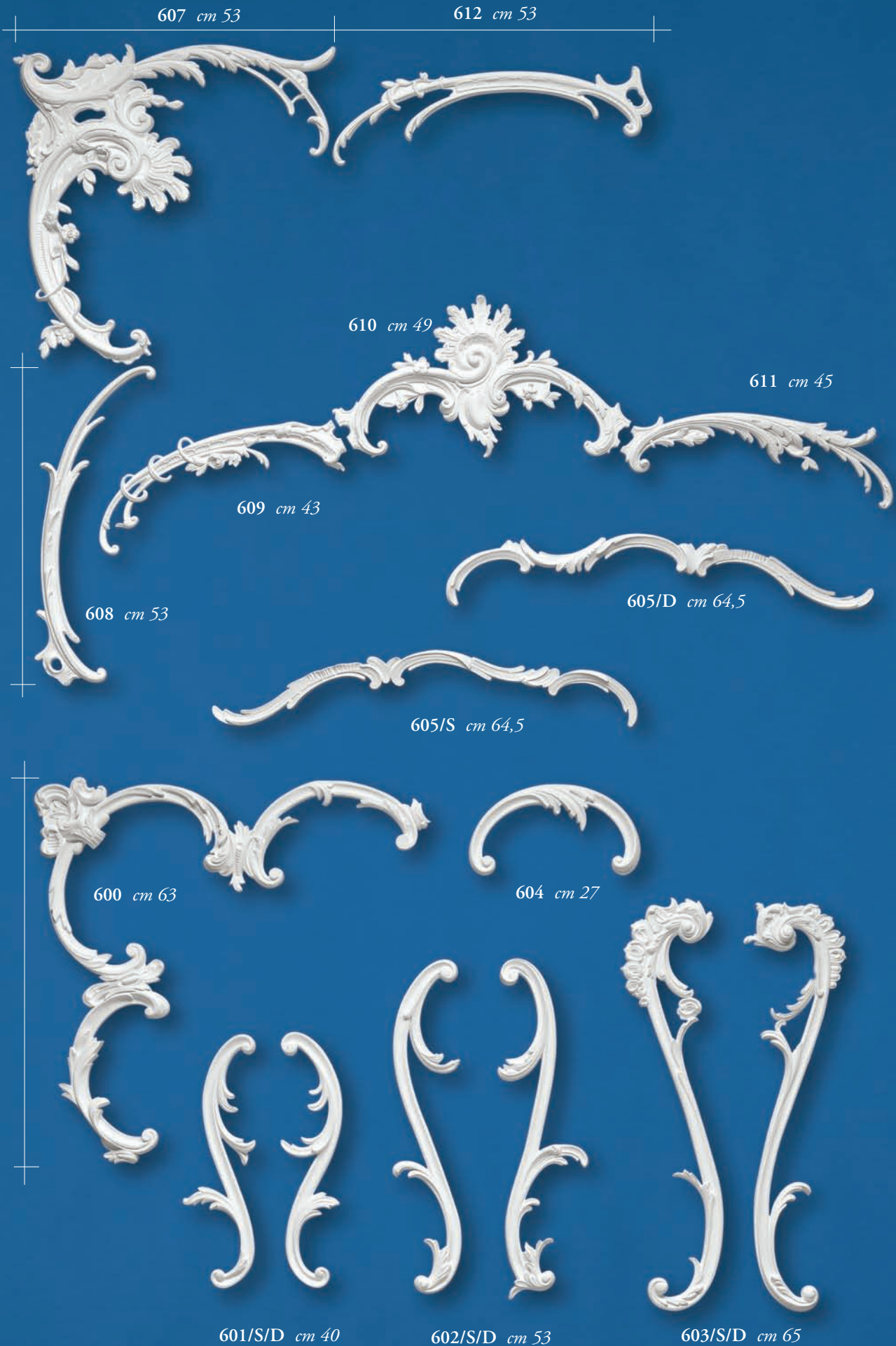

# SOFFITTO BAROCCO

moules décorative • baroque ceiling • decke im barokstil • baroklijsten



630 cm 71x16

631 cm 52,5x21

631 cm 52,5x21



624 cm 26,8x15

632 cm 9,7x32,7

626 cm 30,3

625 cm 49,6x18,6

625 cm 49,6x18,6

632 cm 9,7x32,7



615 cm 32,5x 30

613 cm 68x17

614 cm 33x 40

627 cm 13x12,5



622 cm 17,7x24,5



628 cm 29x11

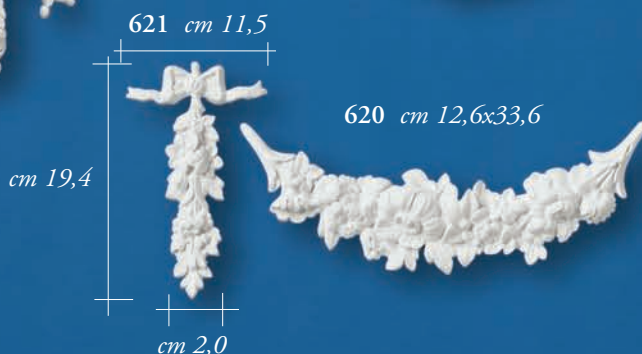

601 cm 11,5

620 cm 12,6x33,6

cm 19,4

cm 2,0



623 cm 18,5x20,6



SOFFITTO BAROCCO

moultures décorative • baroque ceiling • decke im barokstil • baroklijsten

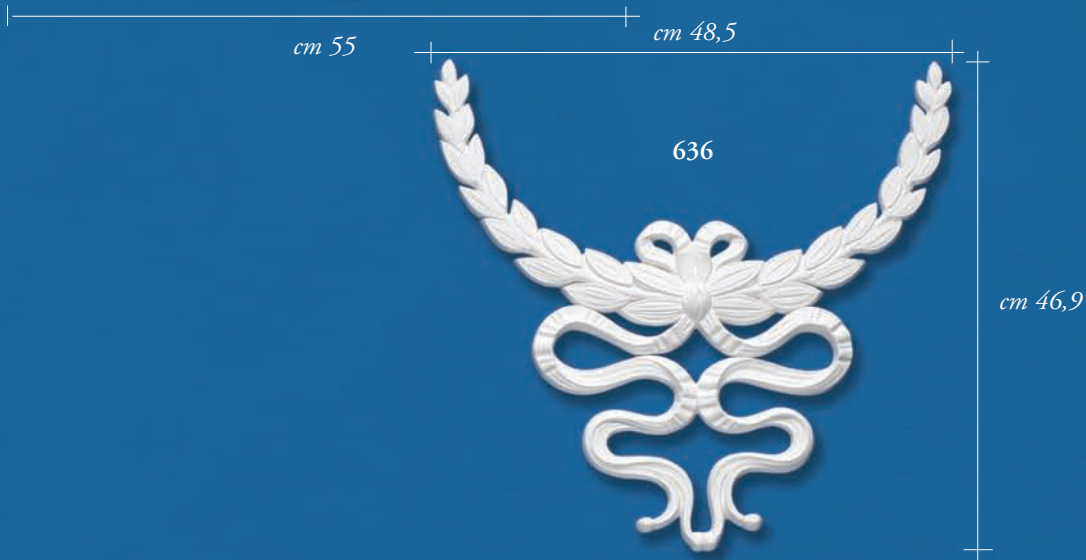
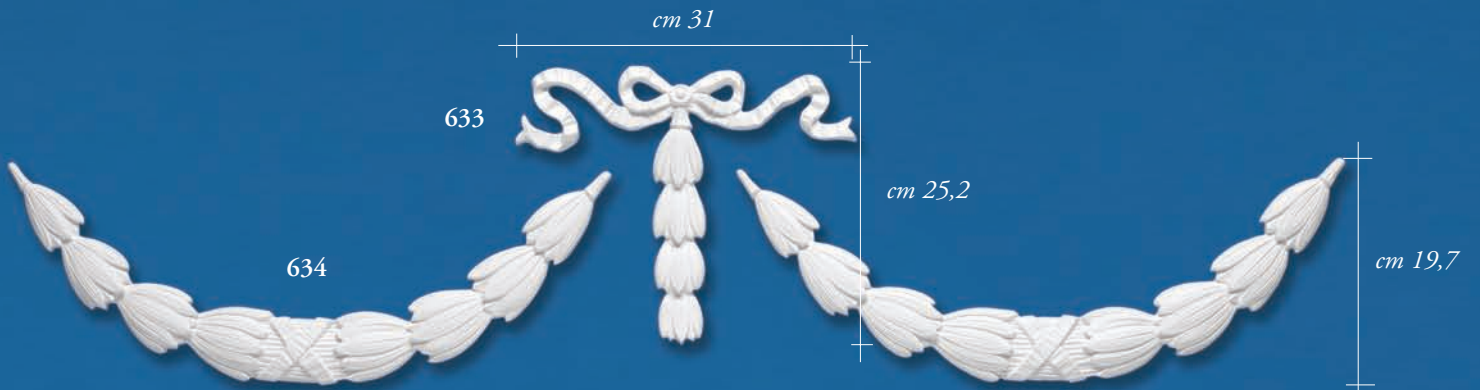

# SOFFITTO BAROCCO

moulores décorative • baroque ceiling • decke im barokstil • baroklijsten

617/S cm 87

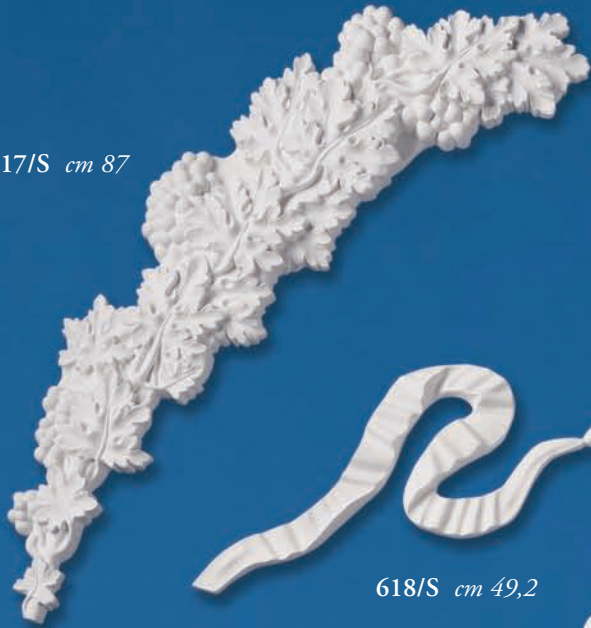

617/D cm 87,6



618/S cm 49,2



618/D cm 48,7



619/D cm 42,9



619/D cm 41,8











63 Ø26



102 cm 21x30



101 Ø27



41 Ø29



440 Ø21



115 Ø30



807 Ø26



37 Ø30



325 Ø31



59 Ø31



439 Ø31



64 Ø30





39 Ø32



405 Ø24



62 Ø32



161 Ø31



304 Ø32



35 Ø32



54 cm 33x24



43 Ø33



303 Ø33





150 Ø33



126 Ø33



158 Ø34



30 Ø36



805 cm 35x26



68 Ø36



42 Ø36



65 Ø34



809 Ø36





402 Ø36,8



34 Ø37



159 cm 37x29



32 Ø37



152 Ø38



324 cm 38x49



318 Ø38



433 Ø38





33 Ø cm 38



315 cm 39x58



38 Ø cm 39



124 Ø cm 40



427 Ø cm 40



944 Ø cm 40,5 / cm 7



920 Ø cm 40

157 cm 40x26



417 Ø cm 40







277 cm 40x28



123 cm 40x30



266 cm 40x30



939 cm 40,1x26,1



305 cm 40x28



432 Ø cm 41



416 Ø cm 40,1



937 Ø cm 40,5





156 Ø41



29 Ø41



58 cm 41x35



148 Ø41



314 Ø42



44 Ø42



401 Ø41,5



307 Ø42





301 Ø42



313 Ø42



36 Ø42



69 Ø42



921 Ø42



808 Ø42



419 Ø43



418 Ø43





153 Ø43



306 Ø43



60 cm 44x23



322 Ø44



414 Ø44,2



317 Ø44



411 Ø44,5



413 Ø45





928 Ø45



28 Ø45



403 cm 45x34



915 Ø45,5



25 Ø46



408 Ø45,6





26 Ø46



27 Ø46



409 Ø47



116 Ø47



425 Ø46,5



428 Ø47





430 Ø47,9



938 Ø49,9



429 cm 48x42



149 Ø49



810 Ø49



327 cm 49x49



316 cm 48x32



61 cm 49x27





913 Ø50



21 Ø50



415 cm 50x35



407 cm 50x45



420 cm 50x37



151 Ø50



112 Ø50



23 Ø50





931 Ø50,2



929 Ø50,5



447 cm 50,3x27,2



423 Ø51,2



434 Ø52



404 cm 52x30



311 Ø52



438 Ø52





146/L Ø52



936 cm 53,5x53,5



914 Ø52



448 Ø52,8



113 Ø53



437 Ø53





119 Ø cm 54



22 Ø cm 55



160 Ø cm 56

943 Ø cm 57,8 / <sup>cm 10</sup>

435 Ø cm 55







207 cm 56x31



49 cm 58x33



308 cm 57x41



24 cm 36x56



48 cm 60x31



421 cm 40x55



422 cm 58,6x42,5



46 cm 59x47





924 Ø 59,2



20 Ø 60



940 cm 60x40



923 Ø 60



927 Ø 60





127 cm 60x42



57 cm 60x53



154 cm 60x42



302 cm 61x45



911 Ø 61



941 Ø 61





47 cm 63x43



436 cm 64,5x45,7



56 cm 64x46



443 Ø 63



99 cm 65x40



309 cm 65x40



45 cm 64x32





243 Ø 66



242 Ø 66



818 Ø 66



930 Ø 66



444 Ø 69





155 cm 65x42



446 cm 67x45



932 Ø 71



323 cm 69x51



51 cm 72x39





905 Ø 73



925 Ø 73,5



431 cm 77,7x53,7



922 Ø 75



909 Ø 78





906 Ø 84



455 cm 81x59



445 cm 83x59



244 cm 85x55





910 Ø 90



606 cm 87x55



52 cm 90x60



901 cm 95x81





904 Ø 95



942 Ø 91



903 cm 99x80



121/L Ø 95X62



241 cm 110x75





917 Ø 100



907 Ø 114



912 Ø 141



908 cm 146x102





918 Ø 151



902 cm 186x90



PRA39 Ø 39



PRC39 Ø 39



PRE39 Ø 39



PRD39 Ø 39



PRG39 Ø 39



PRS39 Ø 39





PRA52 Ø 52



PRE52 Ø 52



PRD52 Ø 52



PRG52 Ø 52



PRS52 Ø 52

20000 est. Ø cm. 120

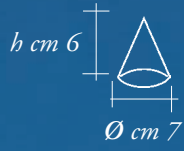





435 Ø int. cm 21,7

435 Ø est. cm 26,5



439 Ø int. cm 25,6

439



433 Ø int. cm 30

433 Ø est. cm 36,7



2111 Ø int. cm 27,5

2111 Ø est. cm 35



2112 Ø int. cm 31,2

2112 Ø est. cm 40



2102 Ø int. cm 31,7

2102 Ø est. cm 45,3



2107 Ø int. cm 50

2107 Ø est. cm 59,6



440 Ø int. cm 55

440 Ø est. cm 59,85



2109 Ø int. cm 47,1

2109 Ø est. cm 60,6



842 Ø int. cm 50,1

842 Ø est. cm 63,5



2103 Ø int. cm 47

2103 Ø est. cm 65,3



843 Ø int. cm 60,2

843 Ø est. cm 66,2



2108 Ø int. cm 60,3

2108 Ø est. cm 67,8



2104 Ø int. cm 46,8

2104 Ø est. cm 70,3



817 Ø int. cm 55,5

817 Ø est. cm 70,2



2110 Ø int. cm 62,2

2110 Ø est. cm 80,5



832 Ø int. cm 60  
2100 Ø int. cm 90  
2106 Ø int. cm 100  
2105 Ø int. cm 110  
2101 Ø int. cm 125

832 Ø est. cm 80  
2100 Ø est. cm 110  
2106 Ø est. cm 120  
2105 Ø est. cm 130  
2101 Ø est. cm 145











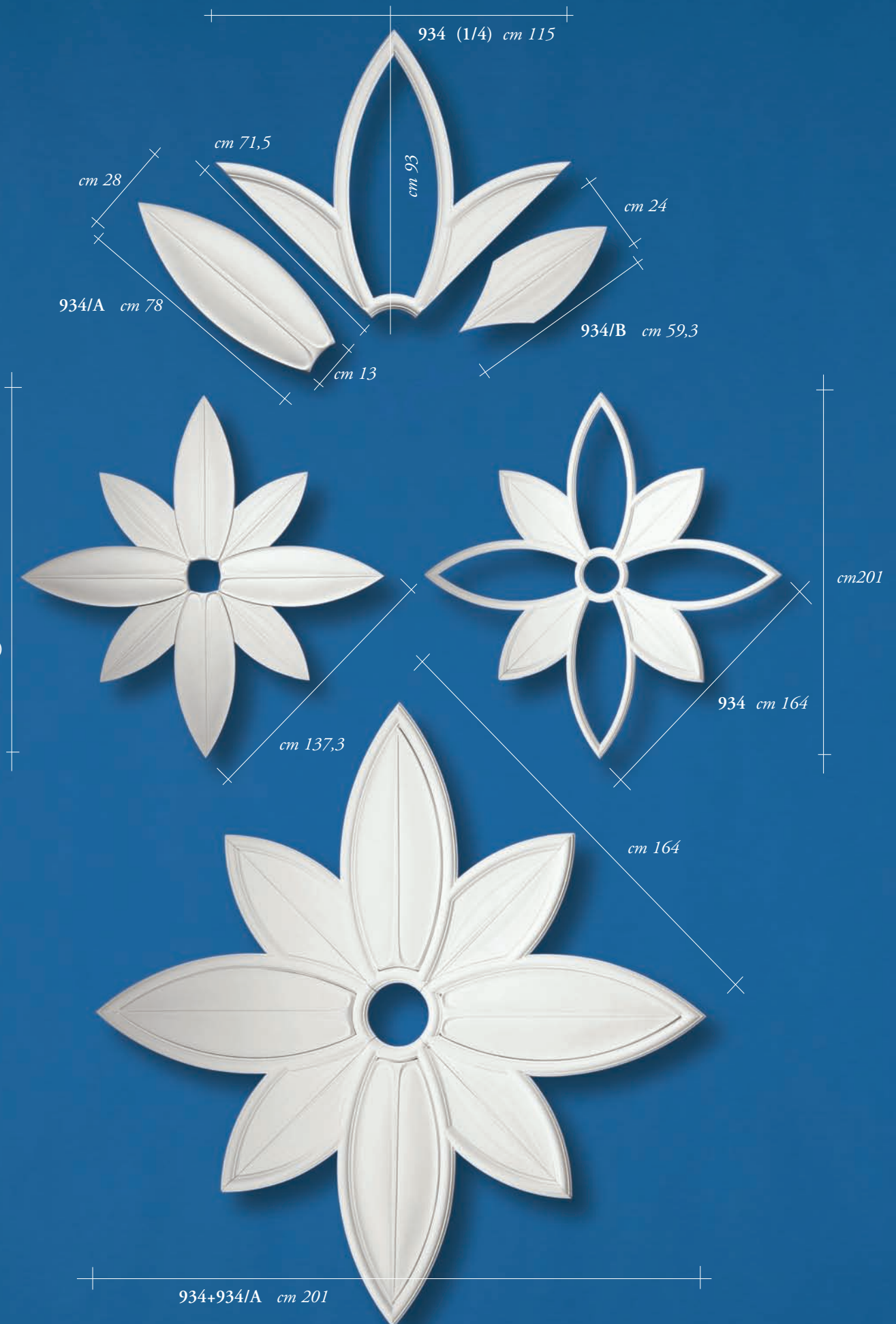

926 cm 191



Ø int. cm 44,7

926/C cm 31

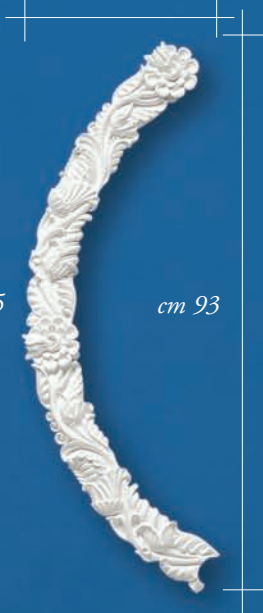

Ø cm 109,5

cm 93

926/B Ø est. cm 62,7



926/A cm 37,5



cm 61



926/D cm 46





508 cm 35



510 cm 35



512 cm 52



263 cm 50



258 cm 49







326/B Ø cm 4,5



105 Ø cm 6



106 Ø cm 6



108 Ø cm 6



109 Ø cm 6



443 Ø cm 6



111 Ø cm 6



120 Ø cm 8



107 Ø cm 7



110 Ø cm 6



PR8 Ø cm 8



437 Ø cm 8



351 Ø cm 9



805 Ø cm 9



4011 cm 5x5

cm 2



821 Ø cm 9



354 Ø cm 9,5



436 Ø cm 11



352 Ø cm 9,5



125 Ø cm 11



50 Ø cm 19



53 Ø cm 20



4002 cm 9,7x9,7



4006 cm 11,5x11,5



4003 cm 9x9



4004 cm 9,7x9,7



4001 cm 15x12



4007 cm 10,5x10,5



104 cm 11x11



4005 Ø cm 11,5



146 cm 12x12



143 Ø cm 11



4000 cm 15,2x11,7



76 Ø cm 12



237 Ø cm 19,5



238 Ø cm 16,5



67 Ø cm 20



130 Ø cm 20





141 Ø cm 13



441 Ø cm 15,8



82 Ø cm 13



72 Ø cm 14



4009 cm 39,8x6,3



273 Ø cm 15



71 Ø cm 15,4



79 Ø cm 15



355 Ø cm 15

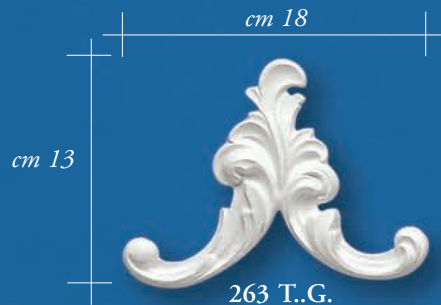

263 T..G.



353 Ø cm 16

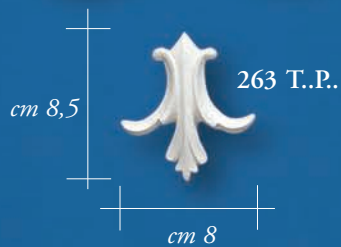

263 T..P.



55 cm 25x20



4008 cm 17,2x4,8



114 cm 25x15



129 Ø cm 15,5



131 Ø cm 15,5



142 Ø cm 16,5



139 Ø cm 16,3



128 Ø cm 16



cm 22,2

4012 cm 23



132 Ø cm 18,5



247 Ø cm 23,5



133 Ø cm 18









245 cm 67x43



4501 cm 81,5x95,5



202 cm 53,2x32



201 cm 36x30



4500 cm 62,5x83



507 cm 63x44





